

Service Manual

TABLE OF CONTENTS

	PAGE
SAFETY CONSIDERATIONS	1
INTRODUCTION	1
MODEL SERIAL NUMBER NOMENCLATURES	2
SPECIFICATIONS	3
DIMENSIONS	4
CLEARANCES	6
ELECTRICAL DATA	7
WIRING	7
CONNECTION DIAGRAM	8
WIRING DIAGRAM	9
REFRIGERATION CYCLE DIAGRAM	10
REFRIGERANT LINES	10
SYSTEM EVACUATION AND CHARGING	11
TROUBLESHOOTING	17
DIAGNOSIS AND SOLUTION	19
APPENDIX	33
DISASSEMBLY INSTRUCTIONS	36

SAFETY CONSIDERATIONS

Installing, starting up, and servicing air-conditioning equipment can be hazardous due to system pressures, electrical components, and equipment location (roofs, elevated structures, etc.).


Only trained, qualified installers and service mechanics should install, start-up, and service this equipment.

Untrained personnel can perform basic maintenance functions such as cleaning coils. All other operations should be performed by trained service personnel.

When working on the equipment, observe precautions in the literature and on tags, stickers, and labels attached to the equipment.

Follow all safety codes. Wear safety glasses and work gloves. Keep quenching cloth and fire extinguisher nearby when brazing. Use care in handling, rigging, and setting bulky equipment.

Read this manual thoroughly and follow all warnings or cautions included in literature and attached to the unit. Consult local building codes and National Electrical Code (NEC) for special requirements.

Recognize safety information. This is the safety-alert symbol . When you see this symbol on the unit and in instructions or manuals, be alert to the potential for personal injury. Understand these signal words: **DANGER**, **WARNING**, and **CAUTION**.

These words are used with the safety-alert symbol. **DANGER** identifies the most serious hazards which **will** result in severe personal injury or death. **WARNING** signifies hazards which **could** result in personal injury or death. **CAUTION** is used to identify unsafe practices which **may** result in minor personal injury or product and property damage. **NOTE** is used to highlight suggestions which **will** result in enhanced installation, reliability, or operation.

WARNING

ELECTRICAL SHOCK HAZARD

Failure to follow this warning could result in personal injury or death.

Before installing, modifying, or servicing system, the main electrical disconnect switch must be in the **OFF** position. There may be more than 1 disconnect switch. Lock out and tag switch with a suitable warning label.

WARNING

EXPLOSION HAZARD

Failure to follow this warning could result in death, serious personal injury, and/or property damage.

Never use air or gases containing oxygen for leak testing or operating refrigerant compressors. Pressurized mixtures of air or gases containing oxygen can lead to an explosion.

CAUTION

EQUIPMENT DAMAGE HAZARD

Failure to follow this caution may result in equipment damage or improper operation.

Do not bury more than 36 in. (914 mm) of refrigerant pipe in the ground. If any section of pipe is buried, there must be a 6 in. (152 mm) vertical rise to the valve connections on the outdoor units. If more than the recommended length is buried, refrigerant may migrate to the cooler buried section during extended periods of system shutdown. This causes refrigerant slugging and could possibly damage the compressor at start-up.

INTRODUCTION

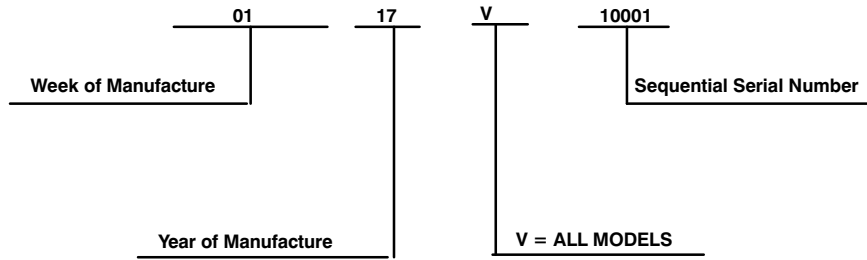
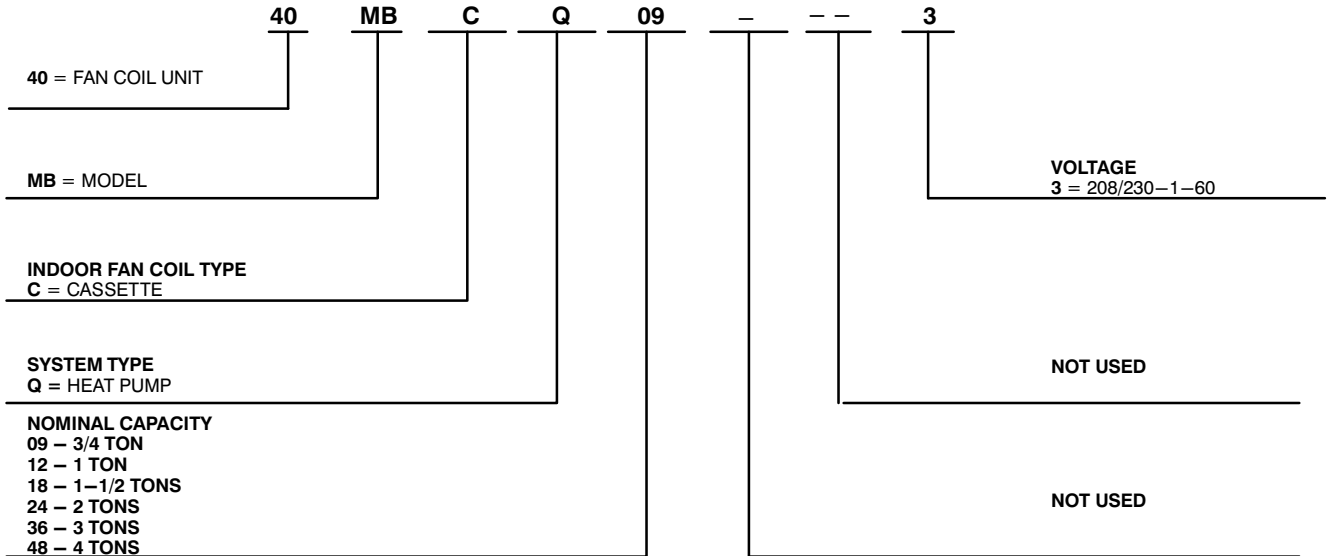
This service manual provides the necessary information to service, repair, and maintain the indoor units. Section 2 of this manual has an appendix with data required to perform troubleshooting. Use the Table of Contents to locate a desired topic.

MODEL SERIAL NUMBER NOMENCLATURES

Table 1—Unit Sizes

kBTUh	V-Ph-Hz	Model No.
9	208/230-1-60	40MBCQ09---3
12	208/230-1-60	40MBCQ12---3
18	208/230-1-60	40MBCQ18---3
24	208/230-1-60	40MBCQ24---3
36	208/230-1-60	40MBCQ36---3
48	208/230-1-60	40MBCQ48---3

INDOOR UNIT



Use of the AHRI Certified TM Mark indicates a manufacturer's participation in the program. For verification of certification for individual products, go to www.ahridirectory.org.



SPECIFICATIONS

Table 2—Cassette (Heat Pump)

		Heat Pump						
System	Size		9	12	18	24	36	48
	Indoor Model		40MBCQ09---3	40MBCQ12---3	40MBCQ18---3	40MBCQ24---3	40MBCQ36---3	40MBCQ48---3
Electrical	Voltage, Phase, Cycle	V/Ph/Hz	208/230-1-60	208/230-1-60	208/230-1-60	208/230-1-60	208/230-1-60	208/230-1-60
	Power Supply		Indoor unit powered from outdoor unit				Indoor unit powered from outdoor unit	
	MCA	A.	0.2	0.2	0.2	0.3	0.8	1.6
Controls	Wireless Remote Controller (° F/° C Convertible)		Standard	Standard	Standard	Standard	Standard	Standard
	Wired Remote Controller (° F/° C Convertible)		Optional	Optional	Optional	Optional	Standard	Standard
Operating Range	Cooling Indoor DB Min —Max	° F (° C)	63~90 (17~32)	63~90 (17~32)	63~90 (17~32)	62~90 (17~32)	63~90 (17~32)	63~90 (17~32)
	Heating Indoor DB Min —Max	° F (° C)	32~86 (0~30)	32~86 (0~30)	32~86 (0~30)	32~86 (0~30)	32~86 (0~30)	32~86 (0~30)
Piping	Pipe Connection Size — Liquid	in (mm)	1/4 (6.35)	1/4 (6.35)	1/4 (6.35)	3/8 (9.52)	3/8 (9.52)	3/8 (9.52)
	Pipe Connection Size — Suction	in (mm)	3/8 (9.52)	1/2 (12.7)	1/2 (12.7)	5/8 (16)	5/8 (16)	5/8 (16)
Indoor Coil	Face Area	Sq. Ft.	3.1	3.1	3.1	3.6	4.6	5.2
	No. Rows		1	2	2	2	3	3
	Fins per inch		19	19	19	18	18	18
	Circuits		2	4	4	8	10	10
Indoor	Body Unit Width	in (mm)	22.44 (570)	22.44 (570)	22.44 (570)	33.07 (840)	33.07 (840)	33.07 (840)
	Body Unit Height	in (mm)	10.24 (260)	10.24 (260)	10.24 (260)	8.07 (205)	9.65 (245)	11.3 (287)
	Body Unit Depth	in (mm)	22.44 (570)	22.44 (570)	22.44 (570)	33.07 (840)	33.07 (840)	33.07 (840)
	Body Net Weight	lbs (kg)	35.27 (16)	35.27 (16)	39.68 (18)	46.3 (21)	58.2 (26.4)	63.27 (28.7)
	Panel Unit Width	in (mm)	25.47 (647)	25.47 (647)	25.47 (647)	37.4 (950)	37.4 (950)	37.4 (950)
	Panel Unit Height	in (mm)	1.97 (50)	1.97 (50)	1.97 (50)	2.17 (55)	2.17 (55)	2.17 (55)
	Panel Unit Depth	in (mm)	25.47 (647)	25.47 (647)	25.47 (647)	37.4 (950)	37.4 (950)	37.4 (950)
	Panel Net Weight	lbs (kg)	5.51 (2.5)	5.51 (2.5)	5.51 (2.5)	11.02 (5)	11.02 (5)	11.02 (5)
	Number of Fan Speeds		3	3	3	3	3	3
	Airflow (lowest to highest)	CFM	260/320/380	280/340/400	290/350/420	625/761/878	809/958/1095	853/1030/1177
	Sound Pressure (lowest to highest)	dB(A)	33/35/38	27/34/42	33/40/46.5	47/50/52	49/52/55	49/52/55
	Air throw Data	ft (m)	23 (7)	23 (7)	30 (9)	30 (9)	30 (9)	30 (9)
	Moisture removal	Pint/h (L/h)	1.58 (0.75)	2.88 (1.366)	4.26 (2.02)	5.22 (2.47)	8.53 (4.04)	13.5 (6.39)
Field Drain Pipe Size O.D.	in (mm)	1 (25.4)	1 (25.4)	1 (25.4)	1 (25.4)	1 (25.4)	1 (25.4)	

NOTE: Performance may vary based on the compatible outdoor units. See respective pages for performance data.

DIMENSIONS

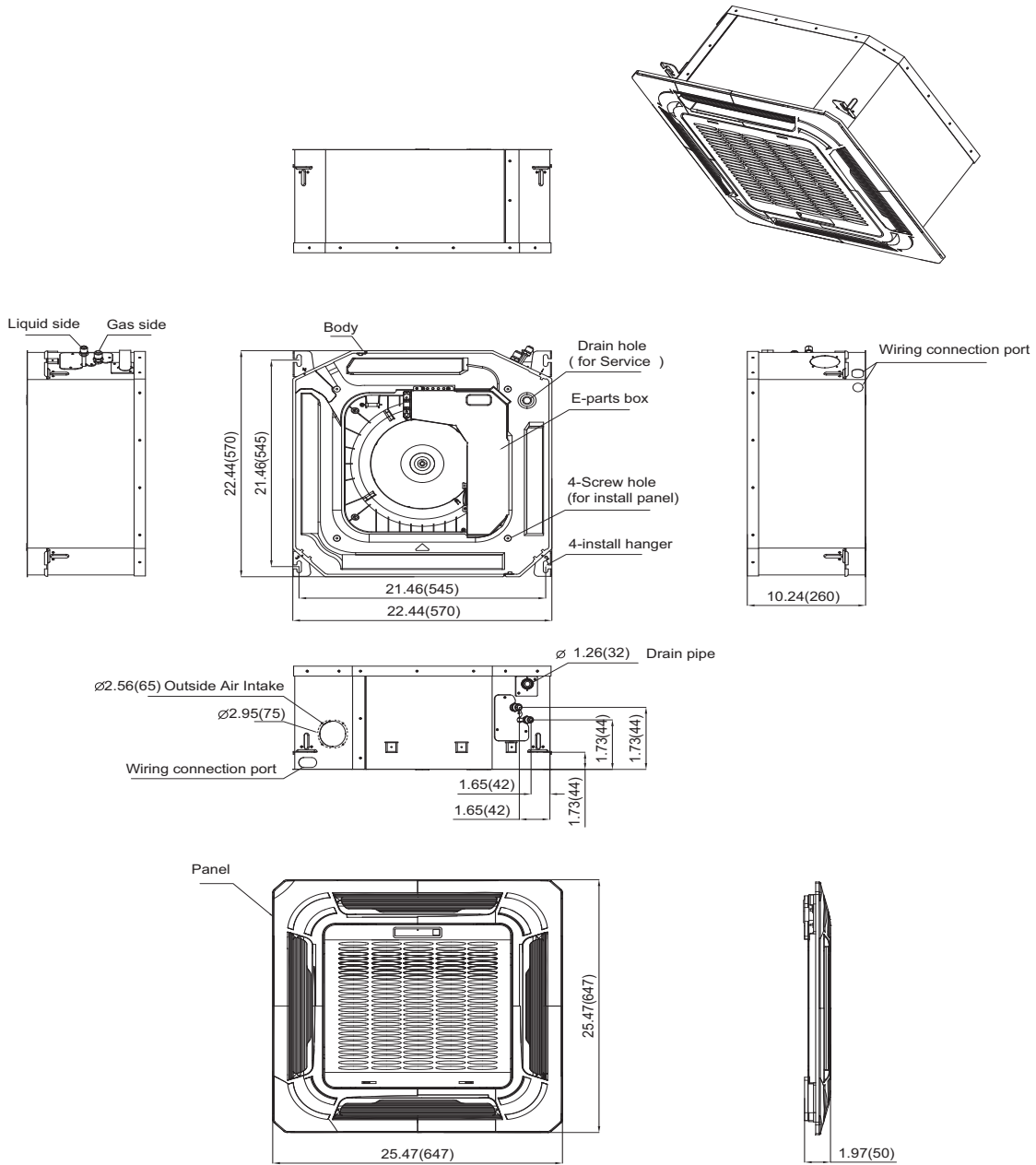
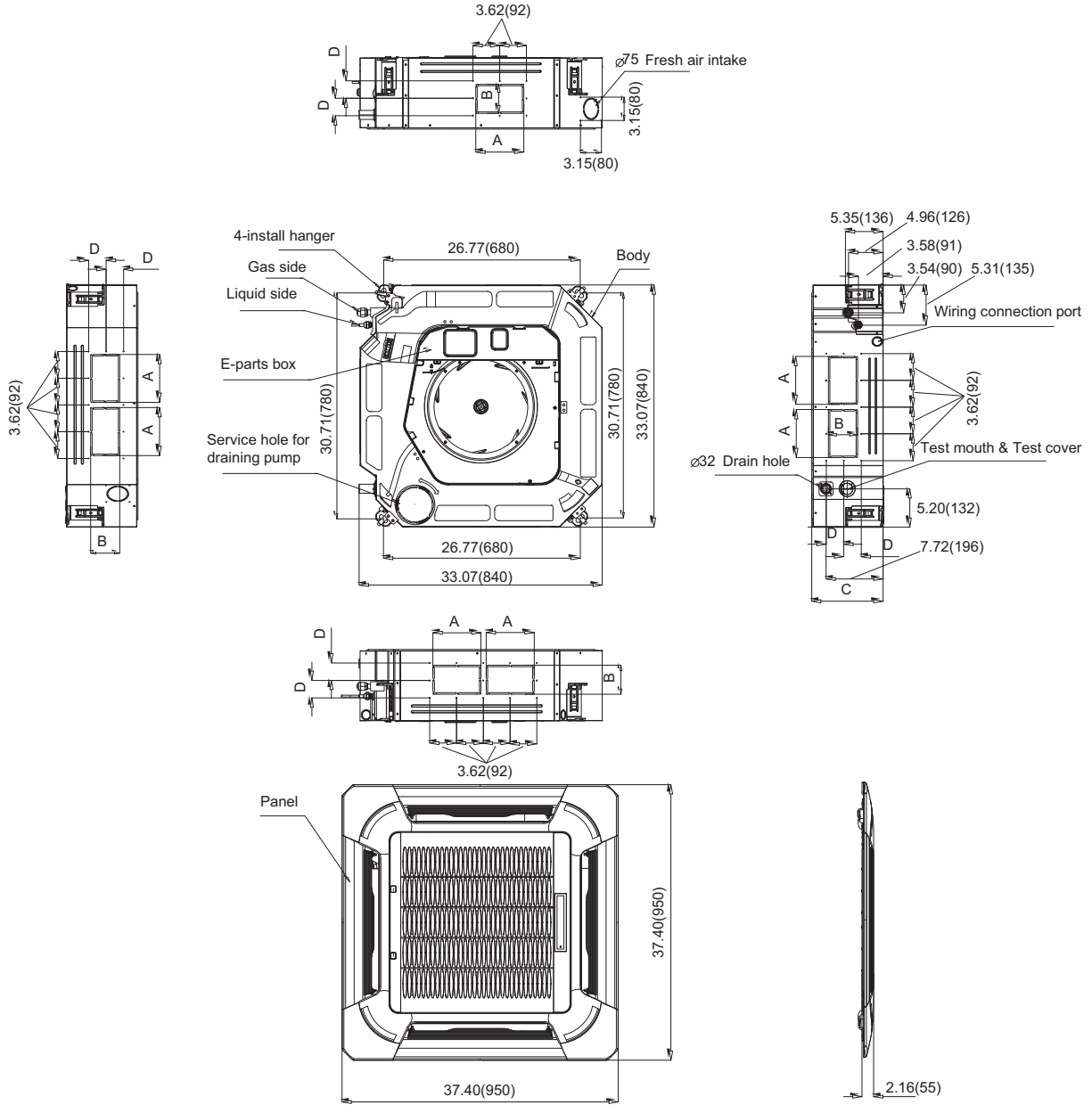


Fig. 1 – Indoor unit (Sizes 09–18)

Table 3—Dimensions

UNIT SIZE		9K		12K		18K		24K		36K		48K	
		Body	Panel	Body	Panel	Body	Panel	Body	Panel	Body	Panel	Body	Panel
DIMENSIONS													
Height	in (mm)	10.24 (260)	1.97 (50)	10.24 (260)	1.97 (50)	10.24 (260)	1.97 (50)	8.07 (205)	2.17 (55)	9.65 (245)	2.17 (55)	11.3 (287)	2.17 (55)
Width	In (mm)	22.44 (570)	25.47 (647)	22.44 (570)	25.47 (647)	22.44 (570)	25.47 (647)	33.07 (840)	37.4 (950)	33.07 (840)	37.4 (950)	33.07 (840)	37.4 (950)
Depth	In (mm)	22.44 (570)	25.47 (647)	22.44 (570)	25.47 (647)	22.44 (570)	25.47 (647)	33.07 (840)	37.4 (950)	33.07 (840)	37.4 (950)	33.07 (840)	37.4 (950)
PACKAGING													
Height	In (mm)	11.42 (290)	4.84 (123)	11.42 (290)	4.84 (123)	11.42 (290)	4.84 (123)	8.54 (217)	3.54 (90)	10.12 (257)	3.54 (90)	11.5 (292)	3.54 (90)
Width	In (mm)	25.79 (655)	28.15 (715)	25.79 (655)	28.15 (715)	25.79 (655)	28.15 (715)	35.43 (900)	40.75 (1035)	35.43 (900)	40.75 (1035)	35.43 (900)	40.75 (1035)
Depth	In (mm)	25.79 (655)	28.15 (715)	25.79 (655)	28.15 (715)	25.79 (655)	28.15 (715)	35.43 (900)	40.75 (1035)	35.43 (900)	40.75 (1035)	35.43 (900)	40.75 (1035)
Weight-Gross	Lbs	41.88 (19)	9.92 (4.5)	41.88 (19)	9.92 (4.5)	46.3 (21)	9.92 (4.5)	54.23 (24.6)	17.64 (8)	66.14 (30)	17.64 (8)	72.53 (32.9)	17.64 (8)
Weight-Net	(kg)	35.27 (16)	5.51 (2.5)	35.27 (16)	5.51 (2.5)	39.68 (18)	5.51 (2.5)	46.3 (21)	11.02 (5)	58.2 (26.4)	11.02 (5)	63.27 (28.7)	11.02 (5)

DIMENSIONS – (CONT.)



Capacity (Btu/h)		A	B	C	D
24K	mm	160	75	205	50
	inch	6.30	2.95	8.07	1.97
36K	mm	160	95	245	60
	inch	6.30	3.74	9.65	2.36
48K	mm	160	95	287	60
	inch	6.30	3.74	11.30	2.36

Fig. 2 – Indoor Unit (Sizes 24–48)

CLEARANCES

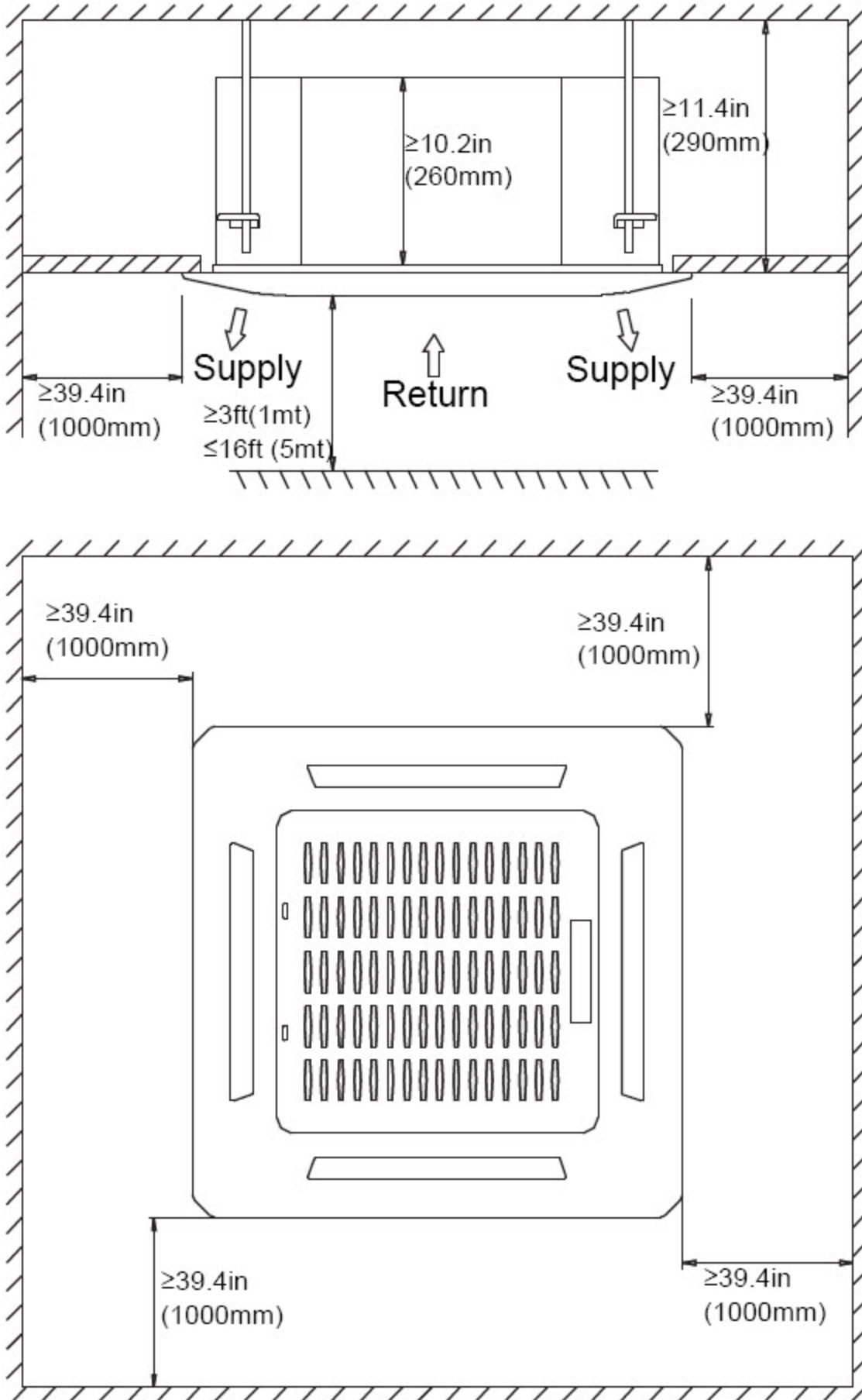


Fig. 3 – Indoor Unit Clearance

ELECTRICAL DATA

Table 4—Cassette Unit

UNIT SIZE	OPER. VOLTAGE MAX / MIN*	INDOOR FAN				MAX FUSE CB AMP
		V—PH—HZ	FLA	HP	W	
9	253 / 187	208—230/1/60	0.146	0.061	46	Refer to outdoor unit installation instructions – Indoor unit powered by the outdoor unit
12			0.146	0.061	46	
18			0.146	0.061	46	
24			0.332	0.057	58	
36			0.8	0.169	141	
48			1.6	0.231	232	

*Permissible limits of the voltage range at which the unit will operate satisfactorily.

LEGEND

FLA – Full Load Amps

WIRING

All wires must be sized per NEC (National Electrical Code) or CEC (Canadian Electrical Code) and local codes. Use Electrical Data table MCA (minimum circuit amps) and MOCP (maximum over current protection) to correctly size the wires and the disconnect fuse or breakers respectively.

Recommended Connection Method for Power and Communication Wiring

Power and Communication Wiring: (09K through 24K)

The main power is supplied to the outdoor unit. The field supplied 14/3 power/communication wiring from the outdoor unit to the indoor unit consists of four (4) wires and provides the power for the indoor unit. Two wires are high voltage AC power, one is communication wiring and the other is a ground wire.

To minimize communication interference: If installed in a high Electromagnetic field (EMF) area and communication issues exist, a 14/2 stranded shielded wire can be used to replace L2 and (S) between outdoor unit and indoor unit – landing the shield onto ground in the outdoor unit only.

Recommended Connection Method for Power and Communication Wiring (36K through 48K) Power Wiring:

The main power is supplied to the outdoor unit. The field supplied power wiring from the outdoor unit to the indoor unit consists of three (3) wires and provides the power for the indoor unit. Two wires are high voltage AC power and one is a ground wire. To minimize voltage drop, the factory recommended wire size is 14/2 stranded with a ground.

Communication Wiring:

A separate shielded stranded copper conductor only, with a 600 volt rating and double insulated copper wire, must be used as the communication wire from the outdoor unit to the indoor unit. Please use a separate shielded 16GA stranded control wire.

CAUTION

EQUIPMENT DAMAGE HAZARD

Failure to follow this caution may result in equipment damage or improper operation.

Wires should be sized based on NEC and local codes.

CAUTION

EQUIPMENT DAMAGE HAZARD

Failure to follow this caution may result in equipment damage or improper operation.

- Be sure to comply with local codes while running wire from indoor unit to outdoor unit.
- Every wire must be connected firmly. Loose wiring may cause terminal to overheat or result in unit malfunction. A fire hazard may also exist. Ensure all wiring is tightly connected.
- No wire should touch refrigerant tubing compressor or any moving parts.
- Disconnecting means must be provided and shall be located within sight and readily accessible from the unit.
- Connecting cable with conduit shall be routed through hole in the conduit panel.

CONNECTION DIAGRAM

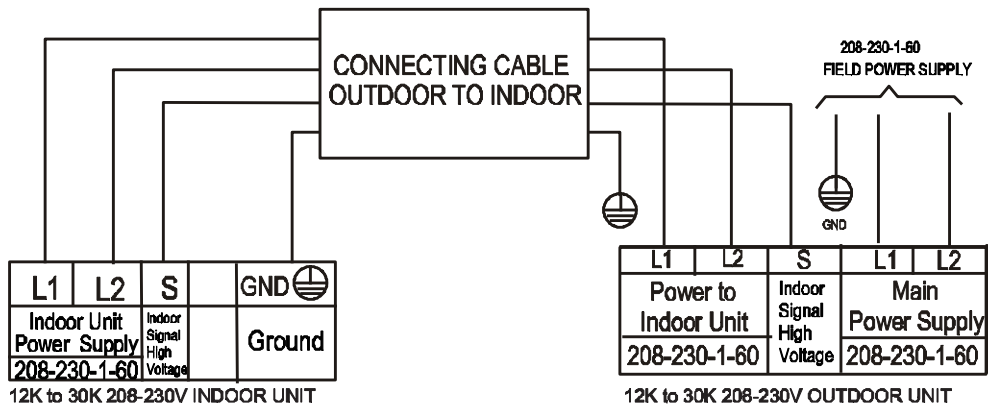


Fig. 4 – Connection Diagrams (Sizes 9–24)

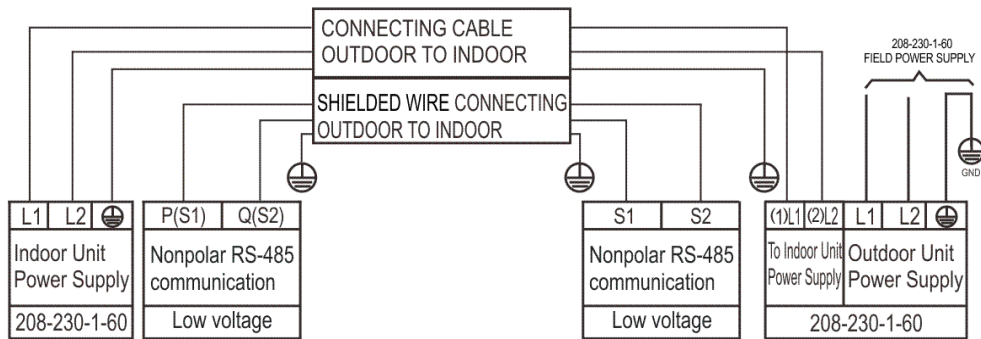


Fig. 5 – Connection Diagrams (Sizes 36–48)

Notes:

1. Do not use the thermostat wire for any connection between indoor and outdoor units.
2. All connections between the indoor and outdoor units must be as shown. **The connections are sensitive to polarity and will result in a fault code.**

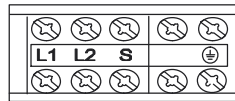


Fig. 6 – Control and Power Wiring on Indoor Unit

WIRING DIAGRAM

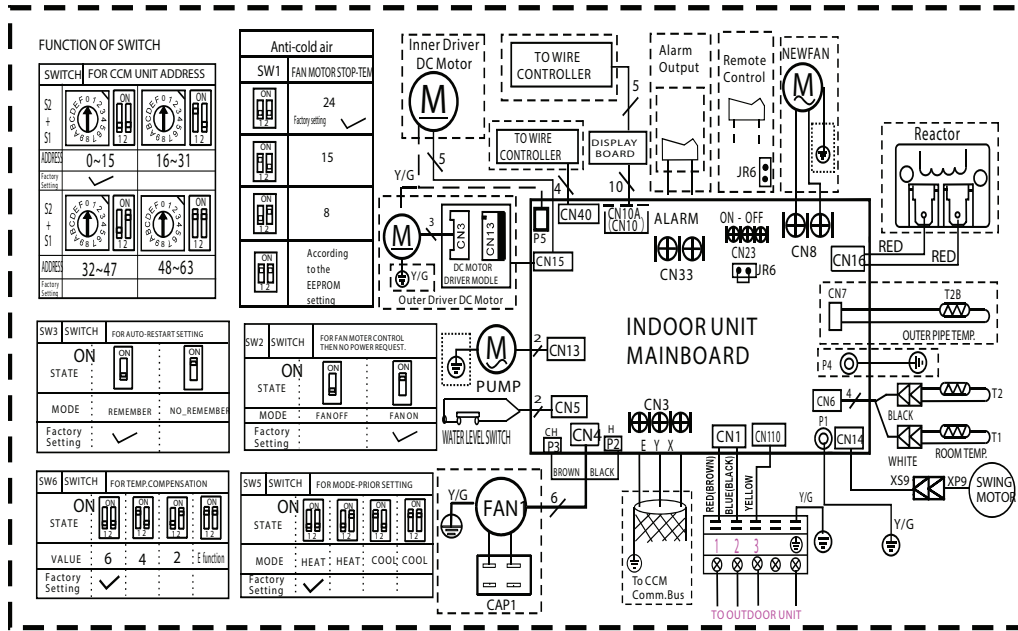


Fig. 7 – Wiring Diagram (Sizes 9K–24K)

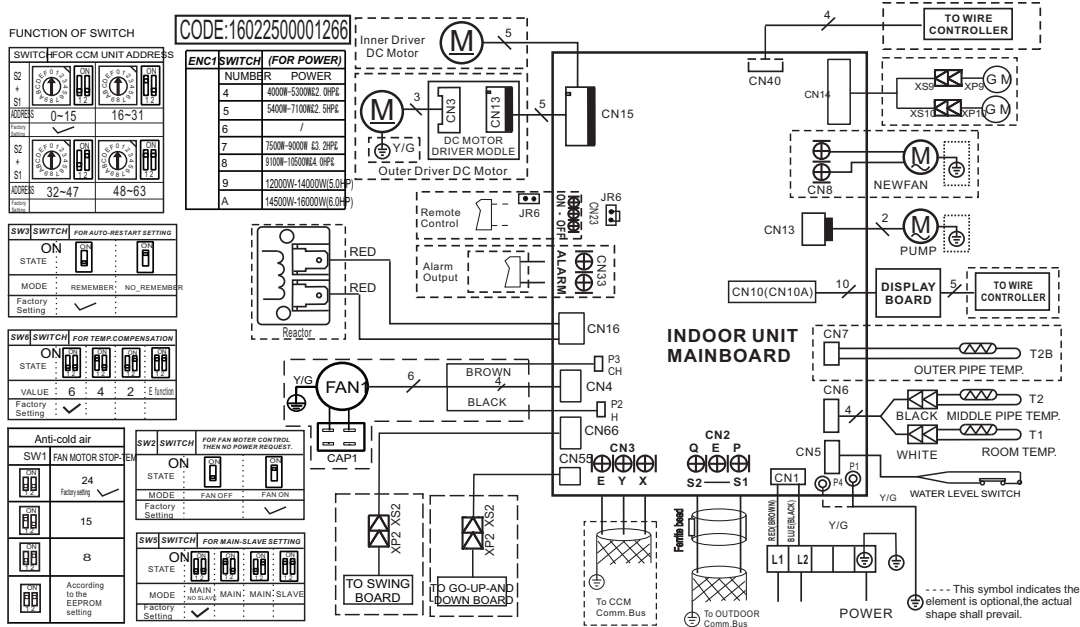


Fig. 8 – Wiring Diagram (Size 36K–48K)

INDOOR UNIT	
CODE	PART NAME
CN1	Input: 230VAC High voltage Connection of the terminal
CN3	Output: 0–5VDC Connection of the CCM
P1	Output: 0V Connection of the earth
CN5	Output: 1–5VDC Connection of the Water level switch
CN6	Output: 5VDC Connection of the Room and Pipe temperature
CN10A	Output: 12VDC Connection of the Display board
CN13	Output: 220VAC High voltage Connection of the Pump
CN14	Output: 12VDC Connection of the Swing motor
CN15	Output: 320VDC High voltage Connection of the DC Fan
CN16	Output: 320VDC High voltage Connection of the Reactor
CN23	Output: 1–12VDC Connection of the Remote switch
CN33	Output: 0V Connection of the Alarm
CN40	Output: 12VDC Connection of the Wire controller
CN110	Output: 24VDC between Pin2 of CN1 connection of the S signal

REFRIGERATION CYCLE DIAGRAM

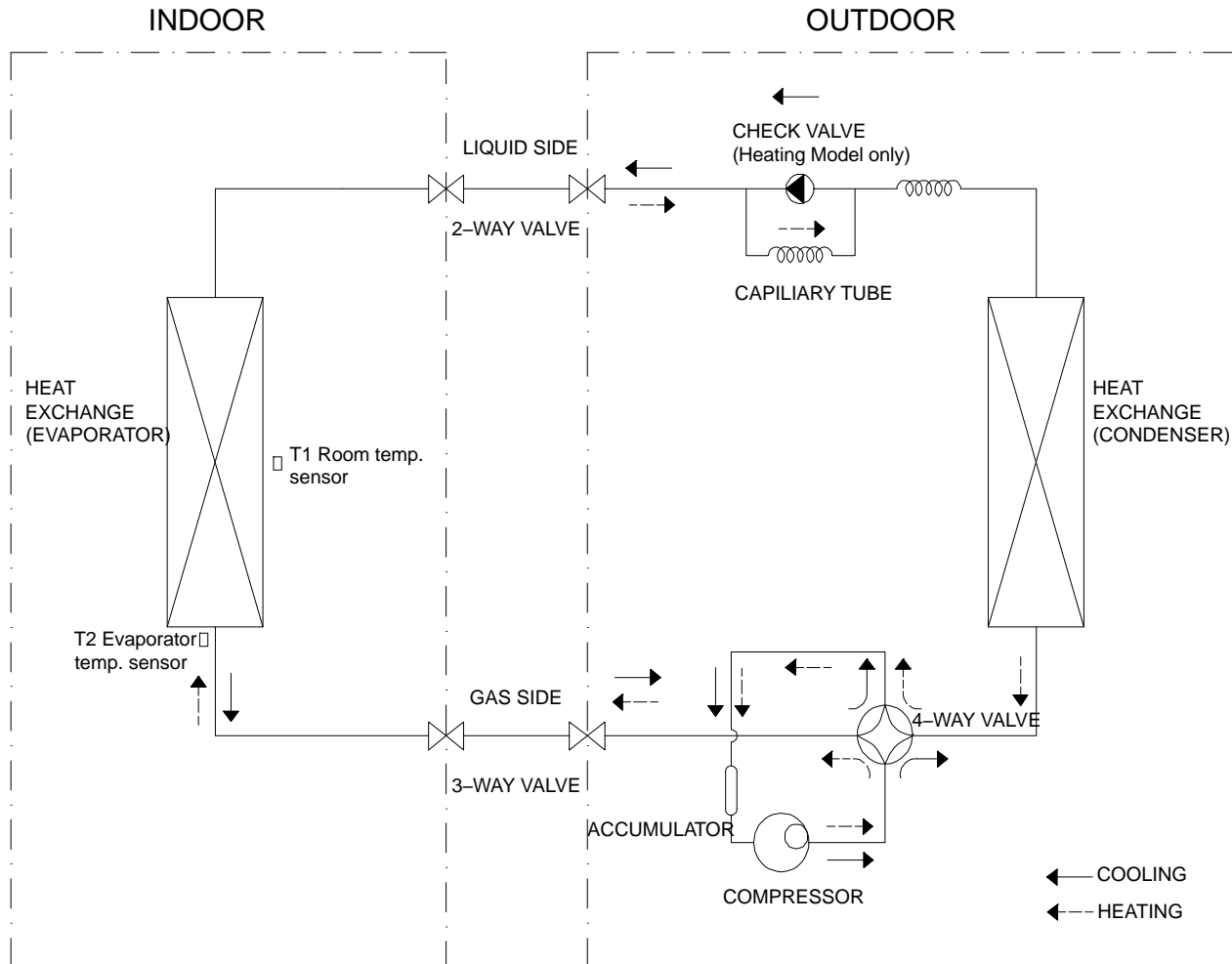


Fig. 9 – Refrigerant Cycle Diagram

REFRIGERANT LINES

General refrigerant line sizing:

1. The outdoor units are shipped with a full charge of R410A refrigerant. All charges, line sizing, and capacities are based on runs of 25 ft. (7.6 m). For runs over 25 ft. (7.6 m), consult the product data.
2. Minimum refrigerant line length between the indoor and outdoor units is 10 ft. (3 m).
3. Refrigerant lines should not be buried in the ground. If it is necessary to bury the lines, not more than 36 in. (914 mm) should be buried. Provide a minimum 6 in. (152 mm) vertical rise to the service valves to prevent refrigerant migration.
4. Both lines must be insulated. Use a minimum of 1/2 in. (12.7 mm) thick insulation. Closed-cell insulation is recommended in all long-line applications.
5. Special consideration should be given to isolating interconnecting tubing from the building structure. Isolate the tubing so that vibration or noise is not transmitted into the structure.
6. For piping runs greater than 25 ft. (7.6 m), add refrigerant up to the allowable length as specified in the product data.

SYSTEM EVACUATION AND CHARGING

⚠ CAUTION

UNIT DAMAGE HAZARD

Failure to follow this caution may result in equipment damage or improper operation.

Never use the system compressor as a vacuum pump.

Refrigerant tubes and indoor coil should be evacuated using the recommended deep vacuum method of 500 microns. The alternate triple evacuation method may be used if the following procedure is followed. Always break a vacuum with dry nitrogen.

System Vacuum and Charge

Using Vacuum Pump

1. Completely tighten the flare nuts (A, B, C, D, E). Fully open all circuits service valves. Connect the manifold gage charge hose to the charge port of the low side Master service valve to evacuate all circuits at the same time (see Fig. 10).
2. Connect charge hose to vacuum pump.
3. Fully open the low side of manifold gage (see Fig. 11).
4. Start vacuum pump.
5. Evacuate using the triple evacuation method.
6. After evacuation is complete, fully close the low side of manifold gage and stop the vacuum pump operation.
7. The factory charge contained in the outdoor unit is good for up to 25 ft. (8 m) of line length.
8. Disconnect charge hose from charge connection of the low side service valve.
9. Fully open service valves B and A.
10. Securely tighten caps of service valves.

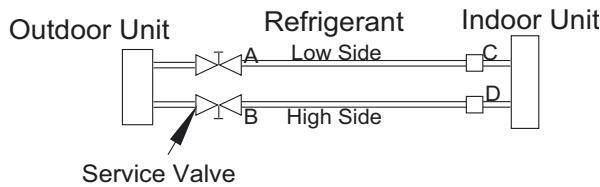


Fig. 10 – Service Valve

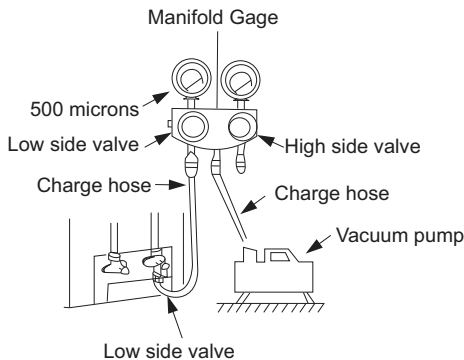


Fig. 11 – Manifold

Deep Vacuum Method

The deep vacuum method requires a vacuum pump capable of pulling a vacuum of 500 microns and a vacuum gage capable of accurately measuring this vacuum depth. The deep vacuum method is the most positive way of ensuring a system is free of air and liquid water (see Fig. 12).

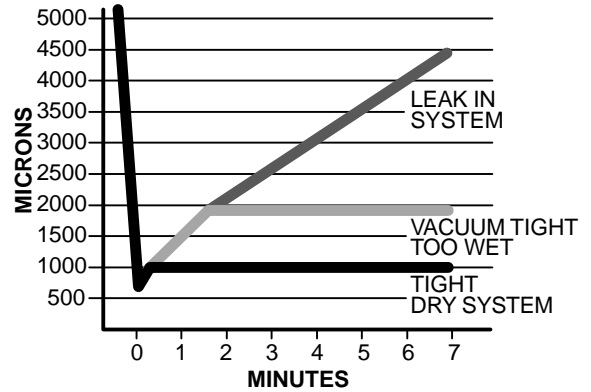


Fig. 12 – Deep Vacuum Graph

Triple Evacuation Method

The triple evacuation method should be used. Refer to Fig. 13 and proceed as follows:

1. Pump the system down to 1500 microns and allow the pump to continue operating for an additional 15 minutes.
2. Close the service valves and shut off the vacuum pump.
3. Connect a dry nitrogen cylinder and regulator to the system and break vacuum until the system reaches 2 psig.
4. Close the service valve and allow the system to stand for one hour. During this time, the dry nitrogen can diffuse throughout the system absorbing moisture.
5. Pump the system down to 1000 microns.
6. Break the vacuum with dry nitrogen (2 psig).
7. Pump the system down to 500 microns.
8. Perform the hold test for 30 minutes.

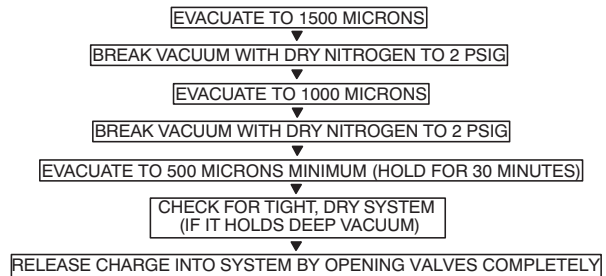


Fig. 13 – Triple Evacuation Method

Final Tubing Check

IMPORTANT: Check to be certain factory tubing on both indoor and outdoor unit has not shifted during shipment. Ensure tubes are not rubbing against each other or any sheet metal. Pay close attention to feeder tubes, making sure wire ties on feeder tubes are secure and tight.

Main Protection

Fan Speed is Out of Control

When the indoor fan speed remains too low (lower than 300RPM) for 50 seconds, the indoor fan will shut off and restarts 30 seconds later, if protection occurred three times when the fan motor restarts continuously, the unit stops and the LED displays the failure. When the outdoor fan speed remains too low (lower than 100 RPM) or too high (higher than 1500 RPM) for 60 seconds, the unit stops and the LED displays the failure. The malfunction is cleared 30 seconds later.

Indoor Fan Delayed Open Function

When the unit starts, the louver becomes active immediately and the indoor fan starts seven seconds later. If the unit runs in the **HEATING** mode, the indoor fan will be controlled by the anti-cold blow function.

Zero Crossing Detection Error Protection

If the AC detects that the time interval is not correct for a continuous period of 240 seconds, the unit stops and the LED displays the failure code. The correct zero crossing signal time interval should be between 6–13ms.

Sensor Protection at Open Circuit and Breaking Disconnection

When there is only one malfunctioning temperature sensor, the air conditioner keeps working yet displays the error code permitting emergency use. When there is more than one malfunctioning temperature sensor, the air conditioner stops working.

Evaporator low temperature T2 protection

- $T_2 < 32^\circ\text{F}$ (0°C), the compressor stops and restarts when $T_2 \geq 41^\circ\text{F}$ (5°C).
- 32°F (0°C) $\leq T_2 < 39.2^\circ\text{F}$ (4°C), the compressor frequency is limited and decreased to the lower level.
- 39.2°F (4°C) $\leq T_2 \leq 44.6^\circ\text{F}$ (7°C), the compressor maintains the current frequency.
- $T_2 > 44.6^\circ\text{F}$ (7°C), the compressor frequency is not limited.

Operation Modes and Functions

FAN Mode

1. Outdoor fan and compressor stop
2. Temperature setting function is disabled, and no setting temperature is displayed
3. Indoor fan can be set to high/med/low/auto
4. The louver operates the same in the **COOLING** mode
5. AUTO Fan

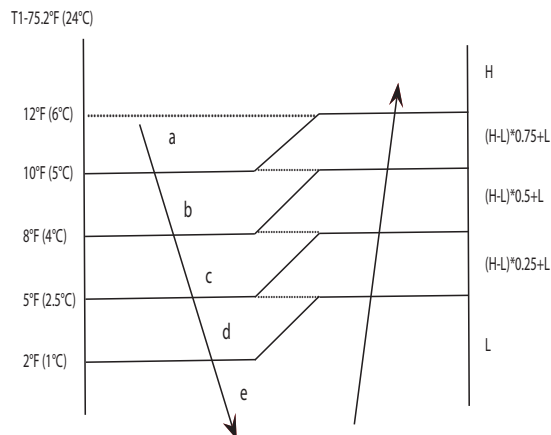


Fig. 14 – Auto Fan

COOLING Mode

Indoor Fan Running Rules

In the **COOLING** mode, the indoor fan runs constantly and the speed can be selected as high, medium, low and auto. When the setting temperature is reached, if the compressor stops running, the indoor fan motor runs at the minimum or setting speed.

The indoor fan is controlled by the rules shown in Fig. 15.

Setting Fan Speed	T1-Td °F (°C)	Actual Fan Speed
H	8°F (4.5°C)	H+ (H+=H+G)
	5°F (3.0°C)	H (=H)
	3°F (1.5°C)	H- (H-=H-G)
M	8°F (4.5°C)	M+ (M+=M+Z)
	5°F (3.0°C)	M (M=M)
	3°F (1.5°C)	M- (M-=M-Z)
L	8°F (4.5°C)	L+ (L+=L+D)
	5°F (3.0°C)	L (L=L)
	3°F (1.5°C)	L- (L-=L-D)

Fig. 15 – Indoor Fan Running Rules

The **AUTO** fan is controlled by the rules shown in Fig. 16.

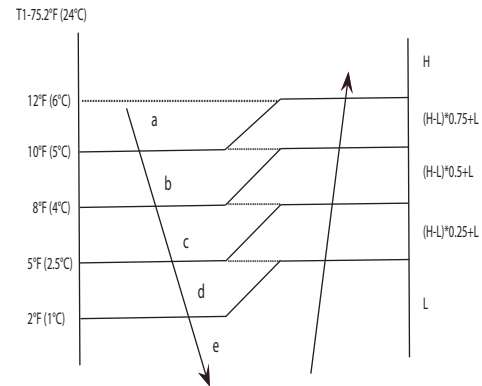


Fig. 16 – Indoor Fan Running Rules

Evaporator Temperature Protection

When the evaporator temperature is less than the setting value, the compressor stops.

HEATING Mode

Indoor Fan Running Rules

When the compressor is on, the indoor fan can be set to high/med/low/auto/mute. When the indoor unit coil temperature is low, the anti-cold air function starts and the indoor fan motor runs at a low speed and the speed cannot be changed. When temperature is lower than the setting value, the indoor fan motor stops.

When the indoor temp reaches the setting temperature, the compressor stops, the indoor fan motor runs at the minimum speed or setting speed. The anti-cold air function is valid. The indoor fan is controlled as shown in Fig. 17.

Setting Fan Speed	T1-Td + 1.5 °C (3°F)	Actual Fan Speed
H	-3°F(-1.5°C)	H- (H=H-G)
	-5°F(-3.0°C)	H (=H)
	-8°F(-4.5°C)	H+(H+=H+G)
M	-3°F(-1.5°C)	M-(M=M-Z)
	-5°F(-3.0°C)	M(M=M)
	-8°F(-4.5°C)	M+(M+=M+Z)
L	-3°F(-1.5°C)	L-(L=L-D)
	-5°F(-3.0°C)	L(L=L)
	-8°F(-4.5°C)	L+(L+=L+D)

Fig. 17 – Indoor Fan Running Rules

Auto Fan Action in HEATING Mode

T1-Td+3°F(1.5°C)

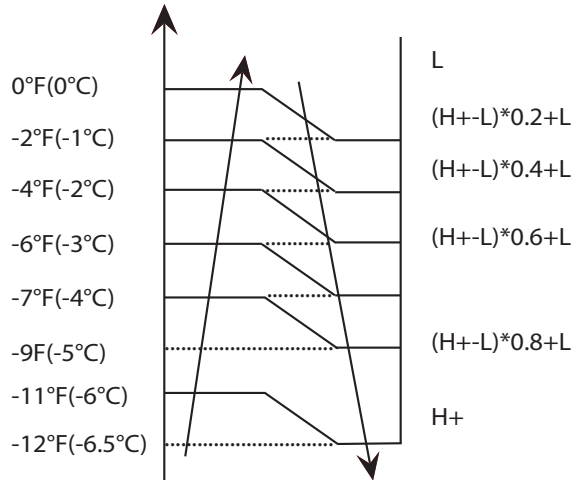


Fig. 18 – Auto Fan Action in HEATING Mode

DEFROSTING Mode

If any one of the following items is satisfied, the unit will enter the **DEFROSTING** mode. After the compressor starts and runs for a while, mark the minimum value of T3 from the 10th minute to the 15th minute as T30.

1. If the compressor runs for 29 minutes and $T3 < TCDI1, T3 + T30SUBT3ONE \cong T30$.
2. If the compressor runs for 35 minutes and $T3 < TCDI2, T3 + T30SUBT3TWO \cong T30$.
3. If the compressor runs for 29 minutes. and $T3 < TCDI3$ for three minutes.
4. If the compressor runs for 120 minutes and $T3 < 5°F (-15°C)$.

Condition of ending defrosting

If any one of the following items is satisfied, the **DEFROSTING** mode ends and the machine reverts to the normal **HEATING** mode.

- T3 increases to a point higher than TCDE1.
- T3 maintains a point higher than TCDE2 for 80 seconds.
- Unit runs for 10 minutes in **DEFROSTING** mode.

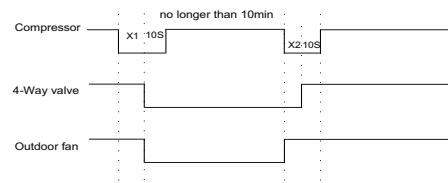


Fig. 19 – Defrosting Action

Evaporator Coil Temperature Protection

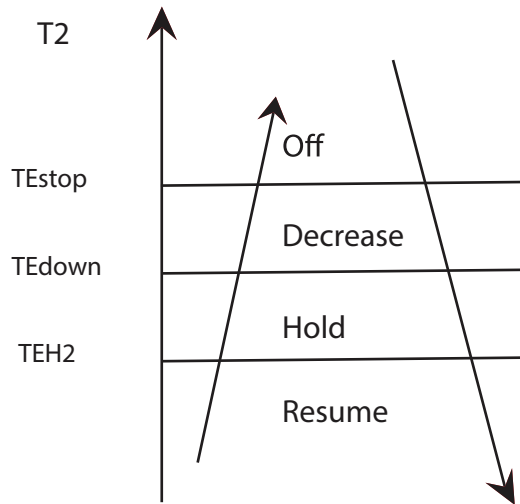


Fig. 20 – Evaporator Coil Temperature Protection

NOTE:

- **Off** – Compressor stops
- **Decrease** – Decrease running frequency to lower level
- **Hold** – Maintain the current frequency
- **Resume** – No frequency limit

When the evaporator temperature is higher than the setting protection value, the compressor stops.

Auto-Mode

This mode can be chosen with the remote controller and the setting temperature can be changed between 62.6°F (17°C)~86°F (30°C).

In the **AUTO** mode, the machine chooses the **COOLING**, **HEATING** or **FAN-ONLY** mode according to $\Delta T (\Delta T = T1 - Ts)$.

Table 5—Evaporator Coil Temperature Protection

$\Delta T = T1 - Ts$	Running Mode
$\Delta T > 4^{\circ}\text{F} (2^{\circ}\text{C})$	Cooling
$-4^{\circ}\text{F} (-2^{\circ}\text{C}) \leq \Delta T \leq 2^{\circ}\text{C} (4^{\circ}\text{F})$	Fan-only
$\Delta T < -2^{\circ}\text{C} (4^{\circ}\text{F})$	Heating

The indoor fan runs under auto fan in the relevant mode. The louver operates same as in relevant mode. If the machine switches mode between **HEATING** and **COOLING**, the compressor stops for a certain time and then chooses the mode according to $T1-Ts$. If the setting temperature is modified, the machine chooses the running function again.

DRYING Mode

Indoor Fan Speed is Fixed

Indoor fan speed is fixed at breeze and can not be changed. The louver angle is the same as in the **COOLING** mode.

Low Indoor Room Temperature Protection

In the **DRYING** mode, if the room temperature is lower than 50°F (10°C), the compressor stops and will not resume until the room temperature exceeds 53.6°F (12°C).

Evaporator Anti-Freezing Protection

The evaporator anti-freezing protection condenser high temperature protection and outdoor unit frequency limit are active and the same as that in **COOLING** mode.

Timer Function

The Timing range is 24 hours.

- **Timer on.** The machine turns on automatically when reaching the setting time.
- **Timer off.** The machine turns off automatically when reaching the setting time.
- **Timer on/off.** The machine turns on automatically when reaching the setting “on” time, and then turns off automatically when reaching the setting “off” time.
- **Timer off/on.** The machine turns off automatically when reaching the setting “off” time, and then turn on automatically when reaching the setting “on” time. The timer function will not change the AC current operation mode.

For example, if AC is off, it will not start up initially after setting the **Timer off** function. When reaching the setting time, the timer LED is off and the AC running mode remains the same. The setting time is relative time.

Sleep Function

The sleep function is available in the **COOLING**, **HEATING** or **AUTO** mode. The operation process in the **SLEEP** mode is as follows:

When cooling, the setting temperature rises 2°F (1°C) (maximum 86°F (30°C)) every one hour. Two hours later, the setting temperature stops rising and the indoor fan is set at low speed.

When heating, the setting temperature decreases 2°F (1°C) (minimum 62.6°F (17°C)) every one hour. Two hours later, the setting temperature stops rising and the indoor fan is set at low speed. The anti-cold wind function has the priority.

Operation time in sleep mode is seven hours. After seven hours, the unit exits this mode and turns off. The Timer setting is available.

FORCED OPERATION Function

When the unit is off, press the touch button to engage the **FORCED AUTO** mode. Press the button again within five seconds to engage the **FORCED COOLING** mode. In the **FORCED AUTO**, **FORCED COOLING** or any other operation mode, press the touch button to turn off the unit.

FORCED OPERATION Mode

In the **FORCED OPERATION** mode, all the general protections and remote control are available.

Operation Rules

FORCED COOLING Mode

The compressor runs at the F2 frequency and the indoor fan runs in the **BREEZE** mode. After running for 30 minutes, the machine enters **AUTO** mode at the 75.2°F (24°C) setting temperature.

FORCED AUTO Mode:

The **FORCED AUTO** mode is the same as the normal **AUTO** mode with a 75.2°F (24°C) setting temperature.

AUTO-RESTART Function

The indoor unit is equipped with the **AUTO-RESTART** function, which is carried out through an auto-restart module. In the event of a sudden power failure, the module memorizes the setting conditions prior to the power failure. The unit resumes the previous operation setting (not including the **SWING** function) automatically three minutes after the power returns.

If the memorization condition is the **FORCED COOLING** mode, the unit will run in the **COOLING** mode for 30 minutes and turn to the **AUTO** mode at the 75.2°F(24°C) setting temperature.

If the air conditioner is off before the power turns off and the air conditioner is required to start up, the compressor delays start up for one minute before powering on. In other instances, the compressor waits three minutes before restarts.

FOLLOW ME

If the indoor PCB receives the signal, which results from pressing **FOLLOW ME** on the remote controller or wired remote controller, the buzzer will emit a sound and this indicates the **FOLLOW ME** function is initiated. However, when the indoor PCB receives the sent from the remote controller every three minutes, the buzzer will not respond. When the unit is running with the **FOLLOW ME** function, the PCB will control the unit according to the temperature from the **FOLLOW ME** signal, and the temperature collection function of the room temperature sensor will be shielded.

When the **FOLLOW ME** function is available, the PCB will control the unit according to the room temperature from the remote controller and the setting temperature.

The PCB will change the mode based on information from the remote controller signal, but it will not be affected by the setting temperature.

If the unit is running under the **FOLLOW ME** function and the PCB does not receive a signal from the remote controller for seven minutes or after pressing **FOLLOW ME** again, the **FOLLOW ME** function will turn off automatically, and the temperature will control the unit according to the room temperature detected from its own room temperature sensor and setting temperature.

Refrigerant Leakage Detection

With this new technology, the display area displays “EC” when the outdoor unit detects a refrigerant leak. This function is only active in cooling mode. It can better prevent compressor damage from refrigerant leakage or compressor overload.

Open Condition: When the compressor is active, the value of the Coil temperature of evaporator T2 has no change or very little change.

Louver Position Memory Function

When starting the unit again after shutting down, the louver returns to the angle originally set by the user, however the precondition is that the angle must be within the allowable range. If it exceeds the range, it will memorize the maximum angle of the louver. During operation, if the power fails or the end user shuts down the unit in **TURBO** mode, the louver returns to the default angle.

46°F (8°C) Heating

When the compressor is running, the indoor fan motor runs without the **ANTI-COLD** air function. When the compressor is off, the indoor fan motor is off.

Silence Operation

Press the **SILENCE** button on the remote controller to initiate the **SILENCE** function. When the **SILENCE** function is activated, the compressor running frequency remains lower than F2 and the indoor unit emits a faint breeze, which reduces the noise to the lowest level and creates a quiet and comfortable environment.

Drain Pump Control

Use the water-level switch to control the action of drain pump.

NOTE: Main action under different condition: every five seconds the system will check the water level one time.

1. When the unit operates under **COOLING** mode (including auto cooling), dehumidifying, and forced cooling mode, the pump will start running immediately and continuously until cooling stops.
2. Once the water level increases to the control point, the LED alarm sounds, the drain pump opens and continues checking the water level. If the water level drops and the LED no longer alarms (drain pump delays for one minute) the system will operate under the last mode set. Otherwise, the entire system stops operating (including the pump) and the LED continues to alarm after three minutes.

Point Check Function

Press the remote controller's **LED DISPLAY** or **LED** or **MUTE** button three times, and then press the **AIR DIRECTION** or **SWING** button three times in ten seconds. The buzzer rings for two seconds. The air conditioner enters into the information enquiry status.

Press the **LED DISPLAY** or **AIR DIRECTION** button to check the next or front item's information.

When the air conditioner enters the information enquiry status, it displays the code name in two seconds (see Table 6).

Table 6—Point Check

Enquiry Information	Displaying Code	Meaning
T1	T1	T1 temp.
T2	T2	T2 temp.
T3	T3	T3 temp.
T4	T4	T4 temp.
T2B	Tb	T2B temp.
TP	TP	TP temp.
TH	TH	TH temp.
Targeted Frequency	FT	Targeted Frequency
Actual Frequency	Fr	Actual Frequency
Indoor fan speed	IF	Indoor fan speed
Outdoor fan speed	OF	Outdoor fan speed
EXV opening angle	LA	EXV opening angle
Compressor continuous running time	CT	Compressor continuous running time
Causes of compressor stop	ST	Causes of compressor stop
Reserve	A0	
Reserve	.b0	
Reserve	.b1	
Reserve	.b2	
Reserve	.b3	
Reserve	.b4	
Reserve	.b5	
Reserve	.b6	
Reserve	.dl	
Reserve	Ac	
Reserve	Uo	
Reserve	Td	

When the AC enters into the information enquiry status, it displays the code value in the next 25 seconds (see Table 7).

Table 7—Point Check

Enquiry Information	Display Value	Meaning	Remark
T1,T2,T3,T4, T2B,TP,TH, Targeted Frequency, Actual Frequency	-1F,-1E,-1d,-1c,-1b,-1A	-25,-24,-23,-22,-21,-20	1. All displaying temperature is actual value 2. All temperature is °C regardless of remote controller used 3. T1,T2,T3,T4,T2B display range: -25~70, TP display range: -20~130 4. Frequency display range: 0~159HZ. 5. If the actual value exceeds the range, it displays the maximum value or minimum value
	-19-99	-19-99	
	A0,A1,...A9	100,101,...109	
	b0,b1,...b9	110,111,...119	
	c0,c1,...c9	120,121,...129	
	d0,d1,...d9	130,131,...139	
	E0,E1,...E9	140,141,...149	
F0,F1,...F9	150,151,...159		
Indoor fan speed /Outdoor fan speed	0	OFF	For some big capacity motors. For some small capacity motors, display value is from 14-FF(hexadecimal), the corresponding fan speed range is from 200-2550RPM
	1,2,3,4	Low speed, Medium speed, High speed, Turbo	
	14-FF	Actual fan speed=Display value turns to decimal value then multiply 10. The unit is RPM.	
EXV opening angle	0-FF	Actual EXV opening value=Display value turns to decimal value and then multiply 2.	
Compressor continuous running time	0-FF	0-255 minutes	If the actual value exceeds the range, it will display the maximum value or minimum value
Causes of compressor stop	0-99	For the detailed meaning, please consult with engineer	Decimal display
Reserve	0-FF		

TROUBLESHOOTING

This section provides the required flow charts to troubleshoot problems that may arise.

NOTE: Information required in the diagnoses can be found either on the wiring diagrams or in the appendix.

Required Tools:

The following tools are needed when diagnosing the units:

- Digital multimeter
- Screw drivers (Phillips and straight head)
- Needle-nose pliers
- Refrigeration gauges

Recommended Steps

1. Refer to the diagnostic hierarchy charts below and determine the problem at hand.
2. Go to the chart listed in the diagnostic hierarchy and follow the steps in the chart for the selected problem.

For ease of service, systems are equipped with diagnostic code display LED's on both the indoor and outdoor units. The outdoor diagnostic display is on the outdoor unit board and is limited to very few errors. The indoor diagnostic display is a combination of flashing LED's on the display panel on the front of the unit. If possible always check the diagnostic codes displayed on the indoor unit first. The diagnostic codes for the indoor and outdoor units are listed in the appendix.

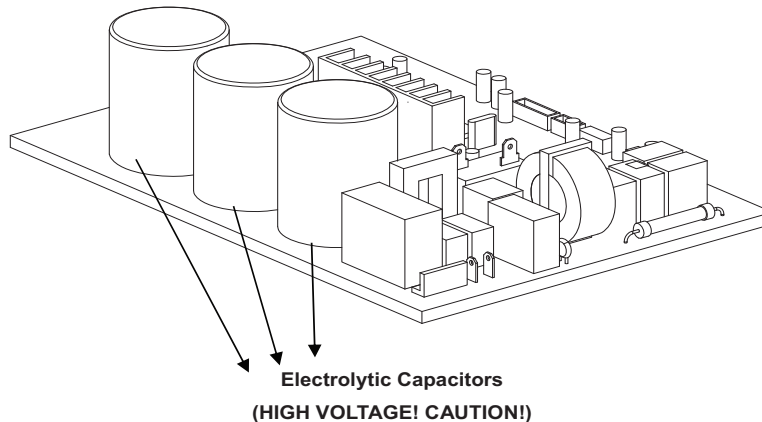
Problems may occur that are not covered by a diagnostic code, but are covered by the diagnostic flow charts. These problems are typical air conditioning mechanical or electrical issues that can be corrected using standard air conditioning repair techniques.

For problems requiring measurements at the control boards, note the following:

1. Always disconnect the main power.
2. When possible check the outdoor board first.
3. Start by removing the outdoor unit top cover.
4. Reconnect the main power.
5. Probe the outdoor board inputs and outputs with a digital multi-meter referring to the wiring diagrams.
6. Connect the red probe to hot signal and the black probe to the ground or negative.
7. Note that some of the DC voltage signals are pulsating voltages for signal. this pulse should be rapidly moving at all times when there is a signal present.
8. If it is necessary to check the indoor unit board you must start by disconnecting the main power.
9. Next remove the front cover of the unit and then control box cover.
10. Carefully remove the indoor board from the control box, place it face up on a plastic surface (not metal).
11. Reconnect the main power and repeat steps 5, 6, and 7.
12. Disconnect main power before reinstalling board to avoid shock hazard and board damage.

Safety

Electricity power is still kept in capacitors even the power supply is shut off. Do not forget to discharge the electricity power in capacitor.



**Electrolytic Capacitors
(HIGH VOLTAGE! CAUTION!)**

Fig. 21 – Capacitors

For other models, connect discharge resistance (approx.100Ω 40W) or soldering iron (plug) between +, – terminals of the electrolytic capacitor on the contrary side of the outdoor PCB.

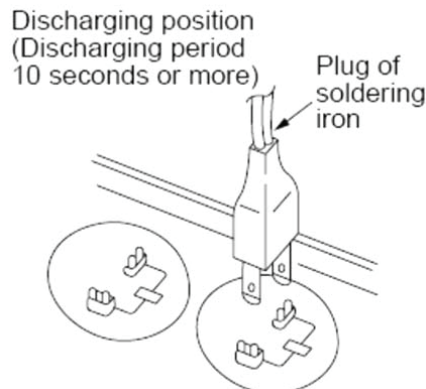


Fig. 22 – Discharging Position

NOTE: Fig. 22 is for reference only.

Indoor Unit Diagnostic Guide

Table 8—Indoor Unit Error Display

Operation Lamp	Timer Lamp	Display	LED Status
☆1 time	X	E0	Indoor unit EEPROM error
☆2 times	X	E1	Communication malfunction between indoor and outdoor units
☆4 times	X	E3	Indoor fan speed has been out of control
☆5 times	X	E4	Indoor room temperature sensor T1 open circuit or short circuit
☆6 times	X	E5	Evaporator coil temperature sensor T2 open circuit or short circuit
☆7 times	X	EC	Refrigerant leakage detection
☆8 times	X	EE	Water—level alarm malfunction
☆1 time	O	F0	Current overload protection
☆2 times	O	F1	Open circuit or short circuit of outdoor ambient temperature sensor T4
☆3 times	O	F2	Open circuit or short circuit of condenser coil temperature sensor T3
☆4 times	O	F3	Open circuit or short circuit of Compressor discharge temperature sensor T5
☆5 times	O	F4	Outdoor unit EEPROM error
☆6 times	O	F5	Outdoor fan speed has been out of control
☆7 times	O	F6	T2B sensor error
☆8 times	O	F7	Lifting—panel communication error
☆9 times	O	F8	Lifting—panel malfunction
☆10 times	O	F9	Lifting—panel is not closed
☆1 time	☆	P0	IPM malfunction
☆2 times	☆	P1	Over voltage or over low voltage protection
☆3 times	☆	P2	High temperature protection of compressor top
☆4 times	☆	P3	Outdoor low temperature protection
☆5 times	☆	P4	Inverter compressor drive error
☆6 times	☆	P5	Mode conflict
☆7 times	☆	P6	Compressor low—pressure protection
☆8 times	☆	P7	Outdoor IGBT temperature sensor error

O (light) X (off) ☆ (flash)

DIAGNOSIS AND SOLUTION

EEPROM error diagnosis and solution (E0/F4)

Error Code	E0/F4
Malfunction decision conditions	Indoor or outdoor PCB main chip does not receive feedback from EEPROM chip.
Probable causes	<ul style="list-style-type: none">• Installation problem• Faulty PCB

Troubleshooting:

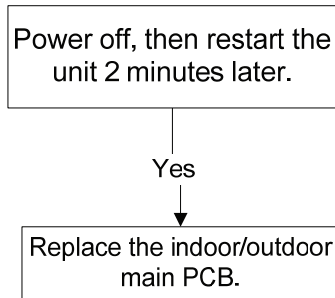


Fig. 23 – Troubleshooting

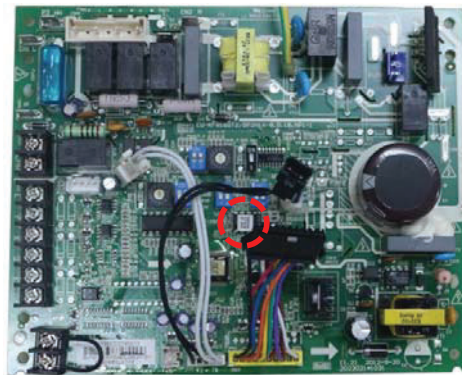


Fig. 24 – Indoor PCB

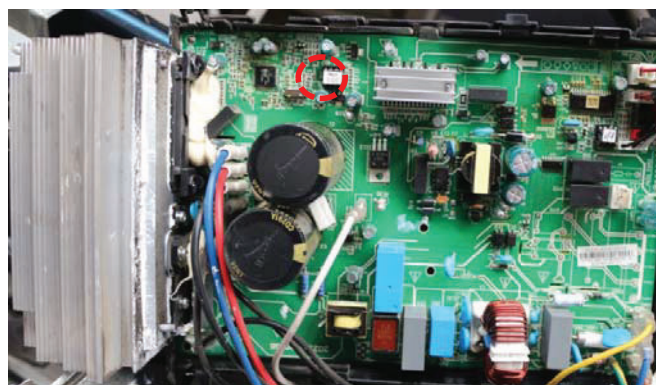


Fig. 25 – Outdoor PCB

NOTE: Fig. 24 and Fig. 25 are for reference only and may differ from the items on your unit.

DIAGNOSIS AND SOLUTION (CONT.)

Communication malfunction between indoor and outdoor units diagnosis and solution (E1)

Error Code	E1
Malfunction decision conditions	Indoor unit does not receive the feedback from outdoor unit during 110 seconds and this condition happens four times consecutively.
Probable causes	<ul style="list-style-type: none"> • Wiring problem • Faulty indoor or outdoor PCB

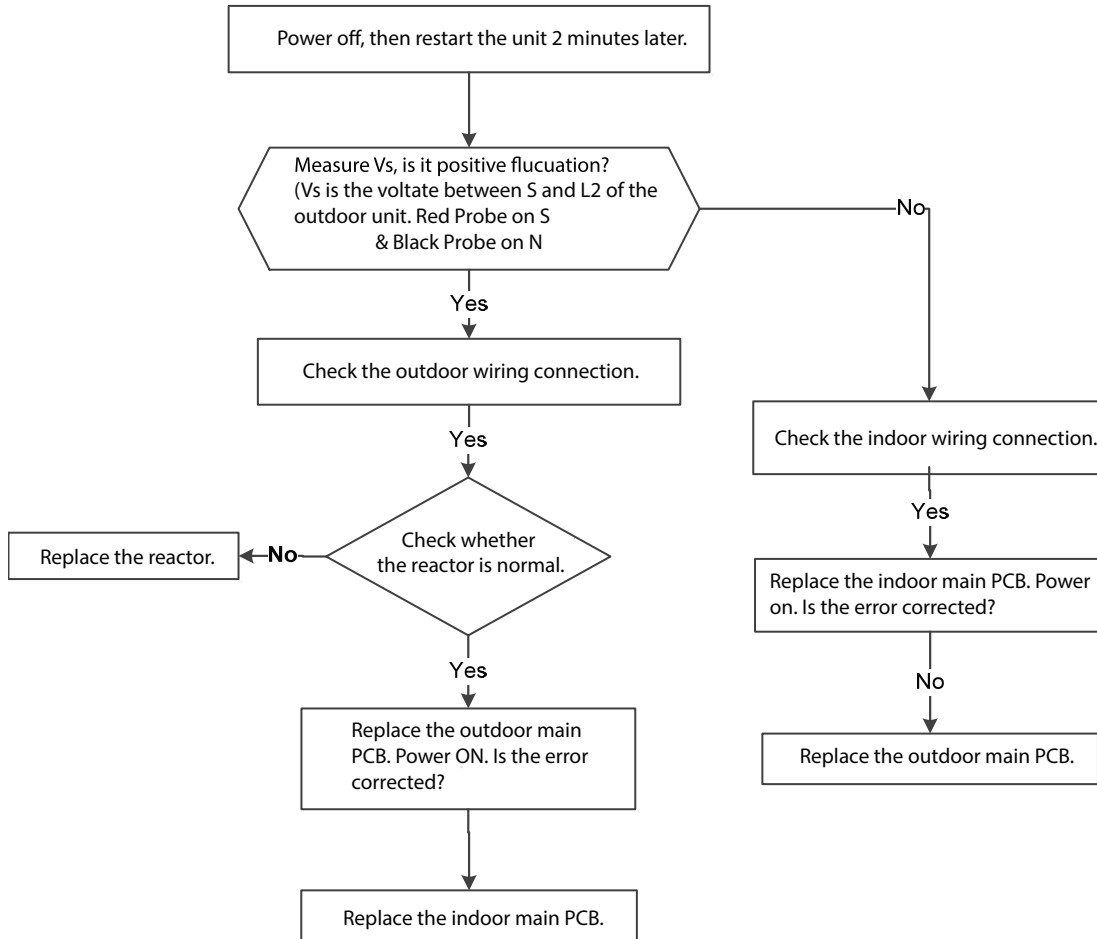


Fig. 26 – Troubleshooting

DIAGNOSIS AND SOLUTION (CONT.)



Fig. 27 – Test the DC voltage

Remark:

Use a multimeter to test the DC voltage between L2 port and S port of outdoor unit. The red probe of the multimeter connects with L2 port while the black pin is for S port.

When the system is running normal, the voltage will move alternately between -50V to 50V.

If the outdoor unit has a malfunction, the voltage will move alternately with positive value.

While if the indoor unit has a malfunction, the voltage will be a fixed value.

DIAGNOSIS AND SOLUTION (CONT.)

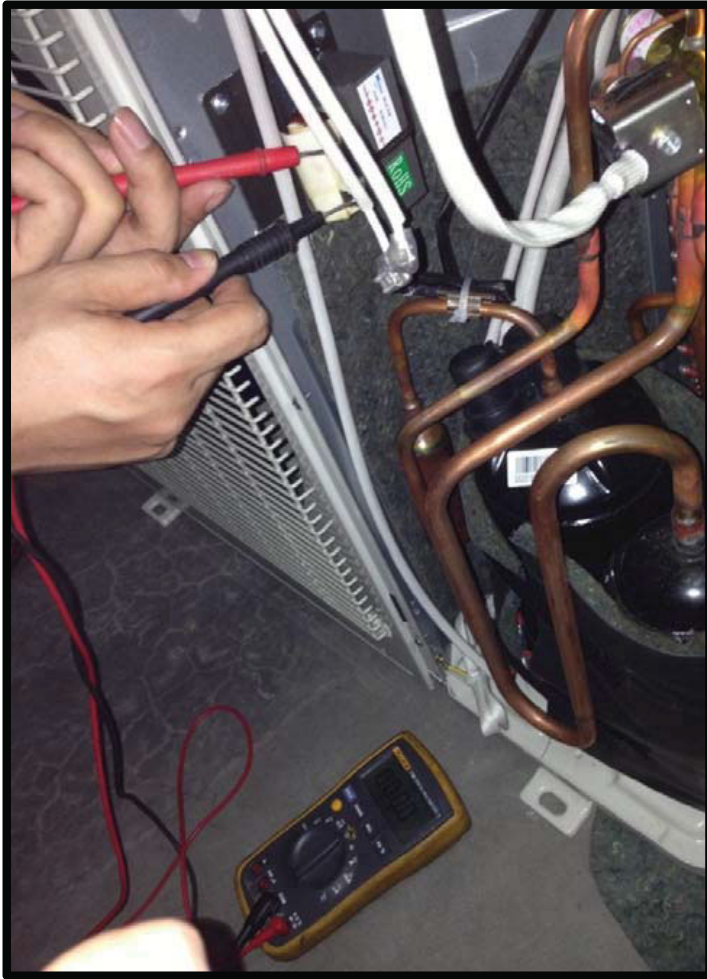


Fig. 28 – Test the resistance

Remark:

Use a multimeter to test the resistance of the reactor with wiring disconnected.

The normal value should be around zero ohm. Otherwise, the reactor is bad and needs to be replaced.

DIAGNOSIS AND SOLUTION (CONT.)

Fan speed is out of control diagnosis and solution (E3)

Error Code	E3
Malfunction decision conditions	When the indoor fan speed remains too low (300RPM), the unit stops and the LED displays the failure.
Probable causes	<ul style="list-style-type: none"> • Wiring problem • Faulty fan assembly • Faulty fan motor • Faulty PCB

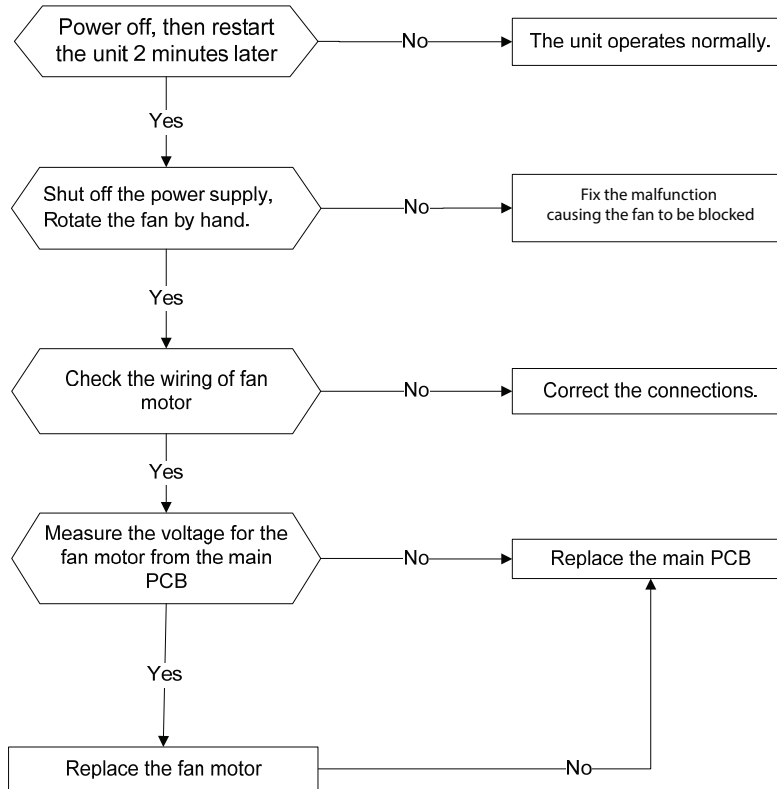


Fig. 29 – Troubleshooting

Index 1:

1. Indoor DC fan motor (control chip is inside fan motor)

Power on and when the unit is in standby, measure the voltage of pin1–pin3, pin4–pin3 in fan motor connector. If the value of the voltage is not in the range showing in table below, the PCB needs to be replaced.

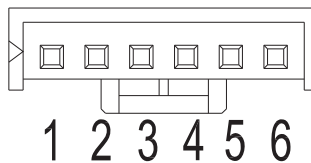


Fig. 30 – Indoor DC fan motor

DC motor voltage input and output

Table 9—Signals

No.	Color	Signal	Voltage
1	Red	Vs/Vm	200~380V
2	---	---	---
3	Black	GND	0V
4	White	Vcc	13.5~16.5V
5	Yellow	Vsp	0~6.5V
6	Blue	FG	13.5~16.5V

DIAGNOSIS AND SOLUTION (CONT.)

Open circuit or short circuit of temperature sensor diagnosis and solution (E4/E5/F1/F2/F3)

Error Code	E4/E5/F1/F2/F3
Malfunction decision conditions	If the sampling voltage is lower than 0.06V or higher than 4.94V, the LED displays the failure.
Probable causes	<ul style="list-style-type: none">• Wiring problem• Faulty sensor

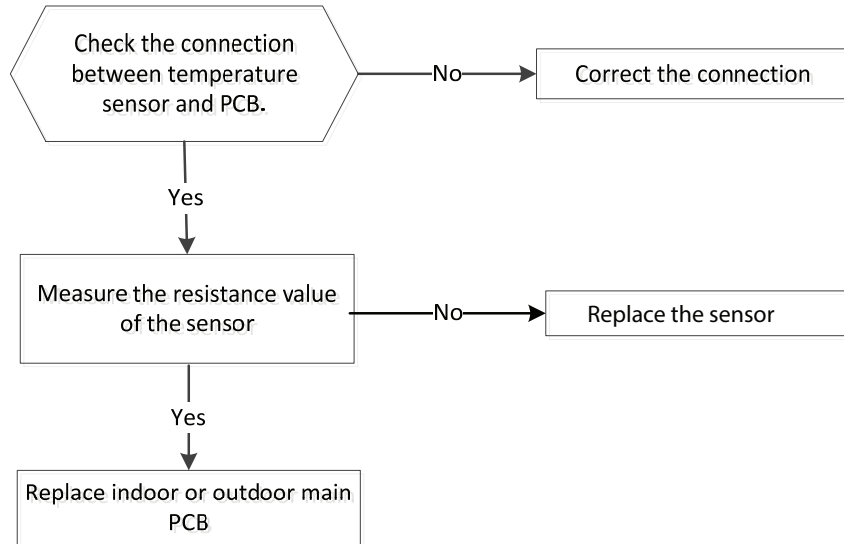


Fig. 31 – Troubleshooting

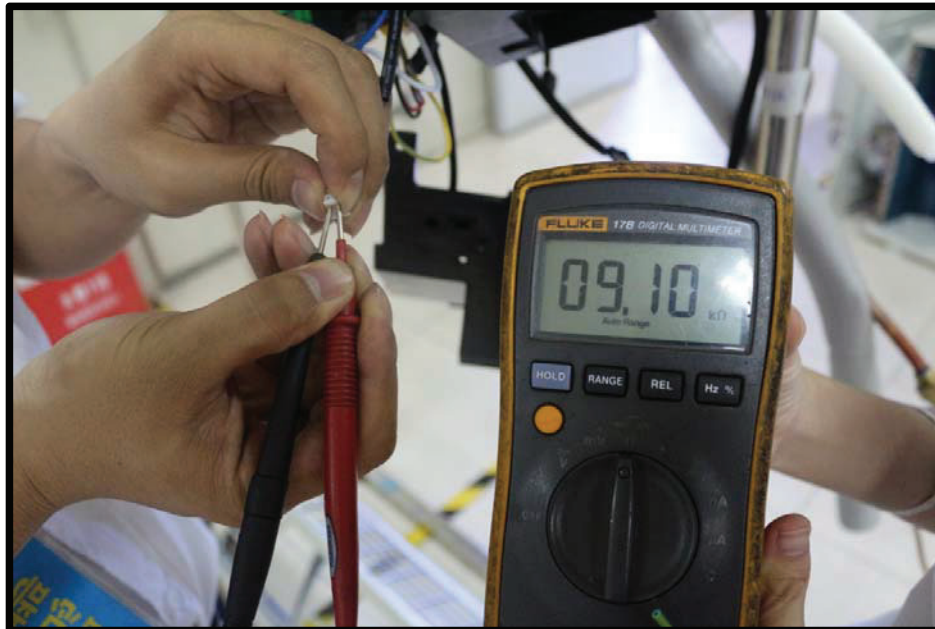


Fig. 32 – Temperature sensor diagnosis

DIAGNOSIS AND SOLUTION (CONT.)

Refrigerant Leakage Detection diagnosis and solution (EC)

Error Code	EC
Malfunction decision conditions	The controls capture the value of T2 when the compressor starts in cool mode and assigns that value to Tcool. After a delay of five minutes with the compressor still running, T2 is compared to Tcool for four seconds. $T2 < Tcool \text{ minus } 4\text{degF (} 2\text{degC)} = \text{OK}$. Otherwise, the temperatures are sampled three times and EC is displayed if T2 temperature is not low enough to indicate sufficient refrigerant flow. Unit will be shut down.
Probable causes	<ul style="list-style-type: none"> Faulty T2 sensor Faulty Indoor FCB System problems, such as leakage or blocking

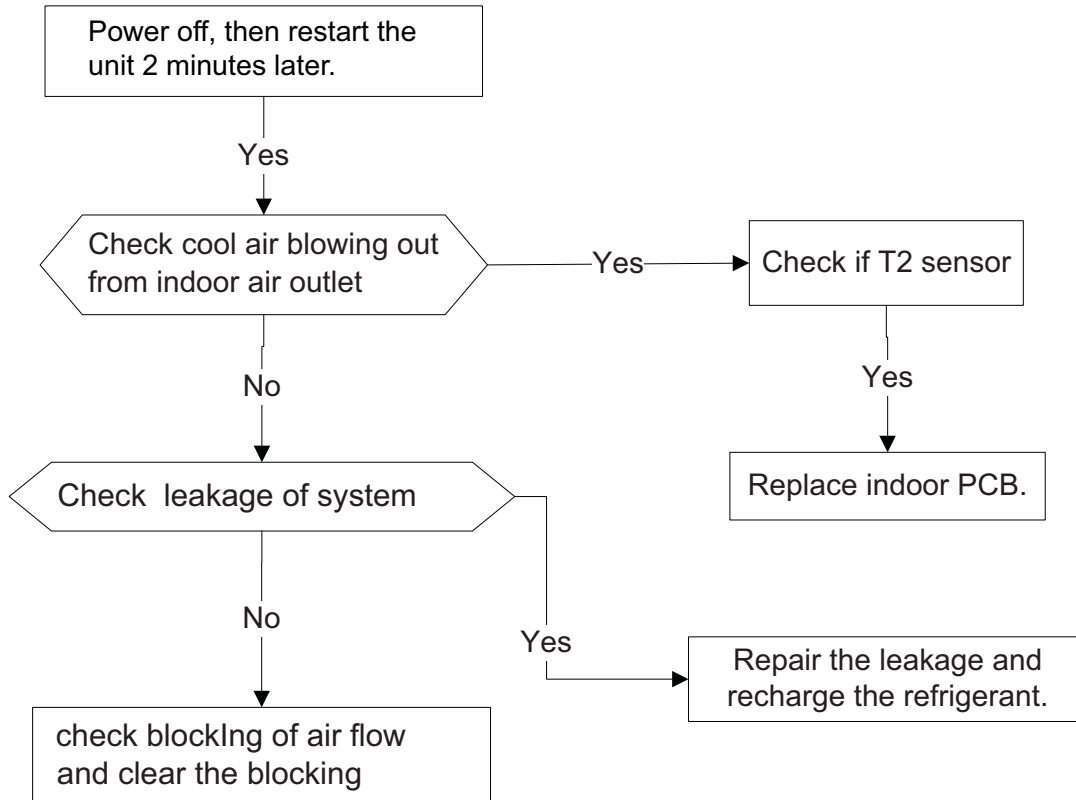


Fig. 33 – Troubleshooting

DIAGNOSIS AND SOLUTION (CONT.)

Water-level alarm malfunction diagnosis and solution

Error Code	EE
Malfunction decision conditions	If the sampling voltage is not 5V, the LED will display the failure.
Probable causes	<ul style="list-style-type: none"> • Wiring problem • Faulty water-level switch • Faulty water pump • Faulty indoor PCB

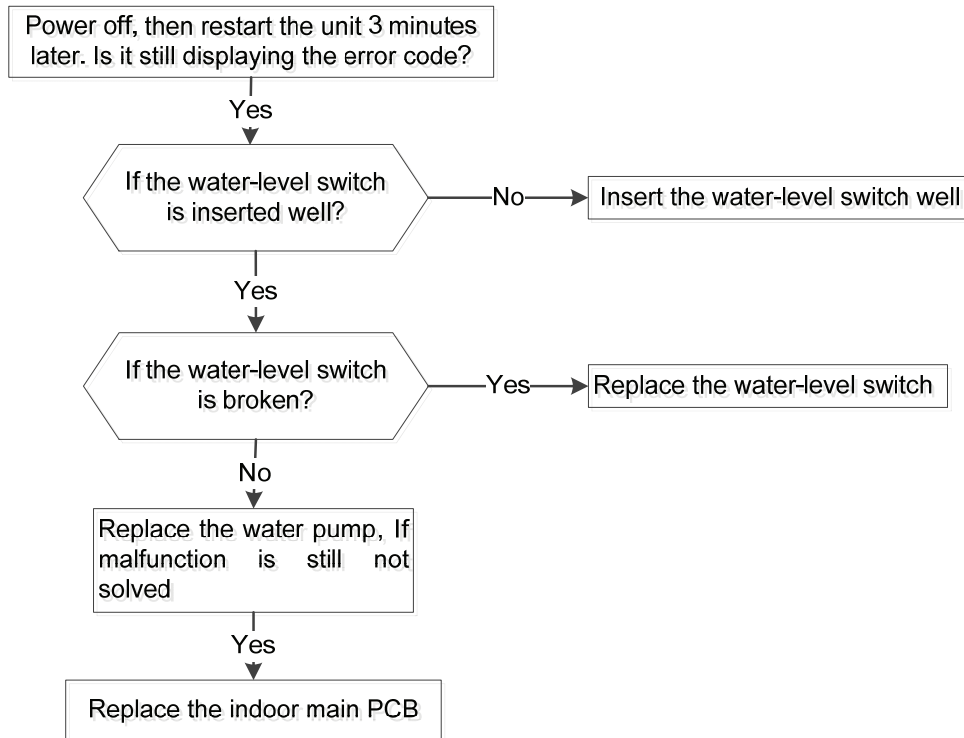


Fig. 34 – Troubleshooting

DIAGNOSIS AND SOLUTION (CONT.)

IPM malfunction or IGBT over-strong current protection diagnosis and solution (P0)

Error Code	P0
Malfunction decision conditions	When the voltage signal that IPM send to compressor drive chip is abnormal, the display LED shows "P0" and unit turns off.
Probable causes	<ul style="list-style-type: none"> • Wiring problem • IPM malfunction • Faulty outdoor fan assembly • Compressor malfunction • Faulty outdoor PCB

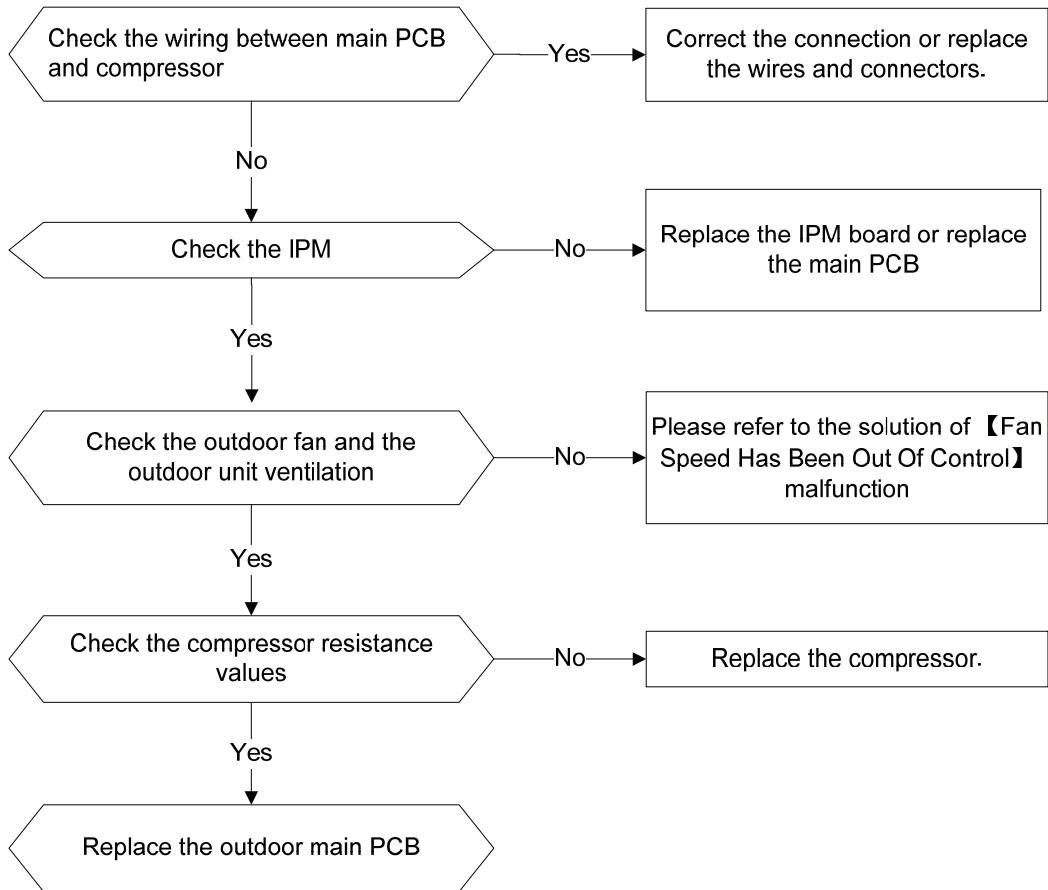
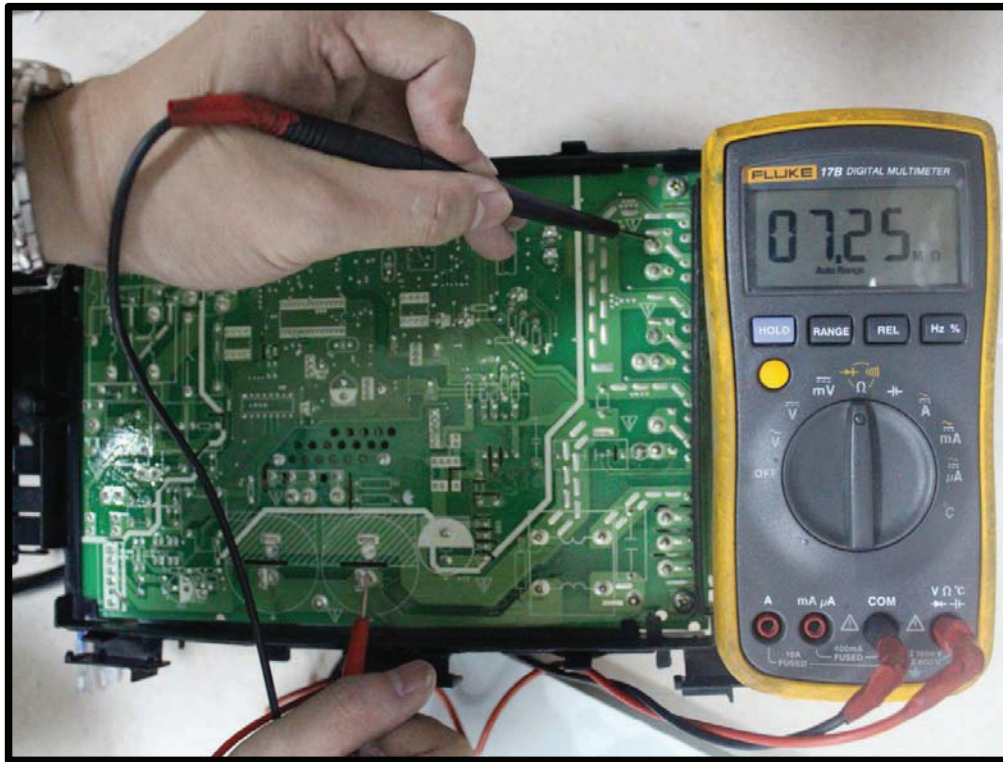


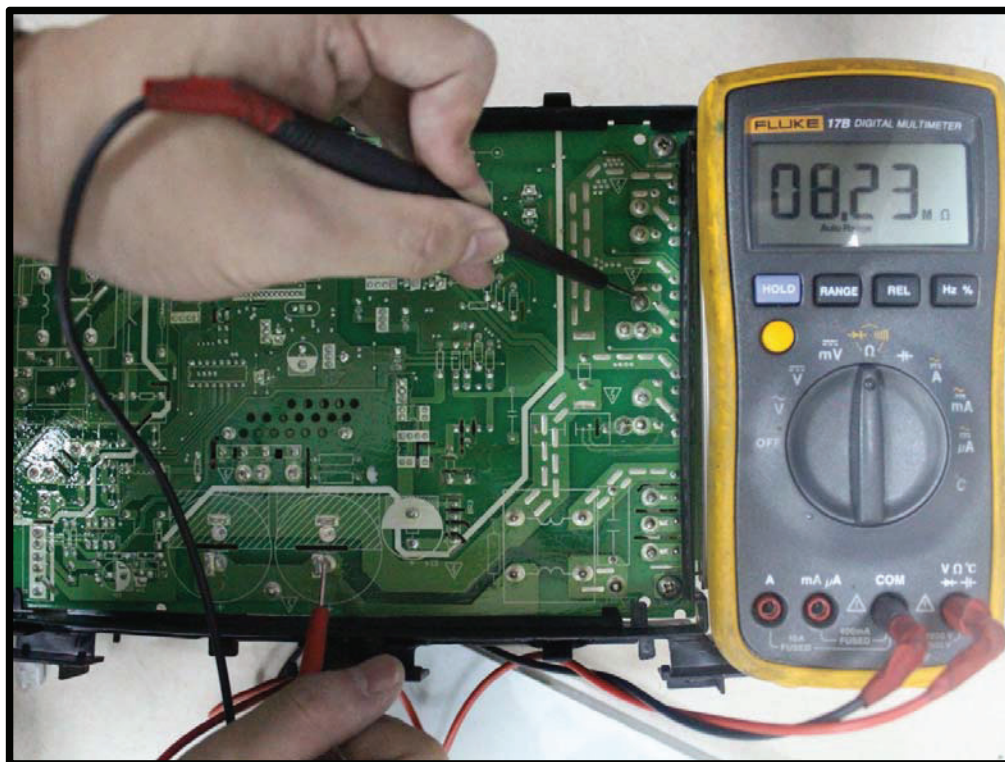
Fig. 35 – Troubleshooting

DIAGNOSIS AND SOLUTION (CONT.)



P-U

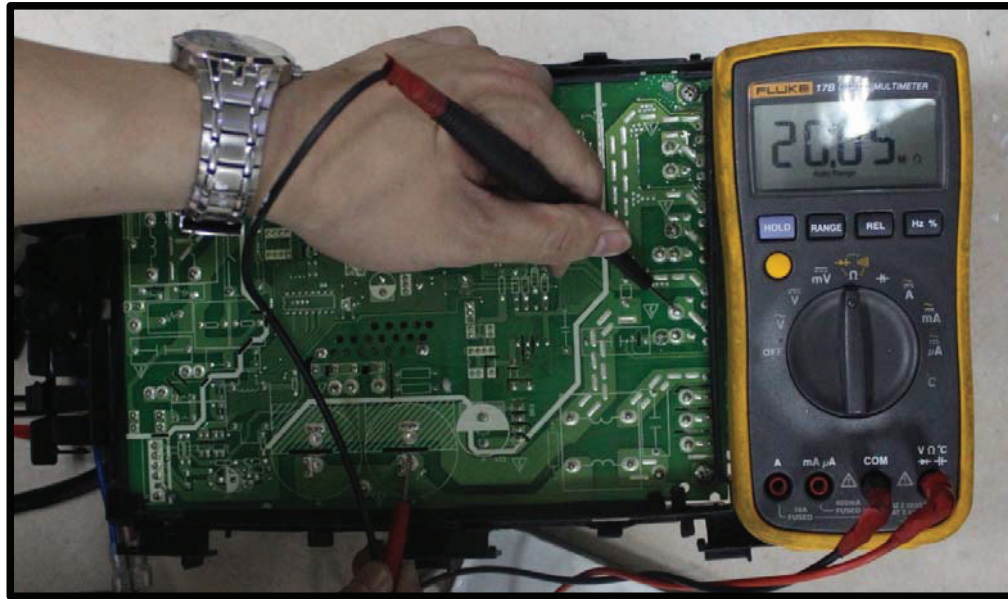
Fig. 36 – P-U



P-V

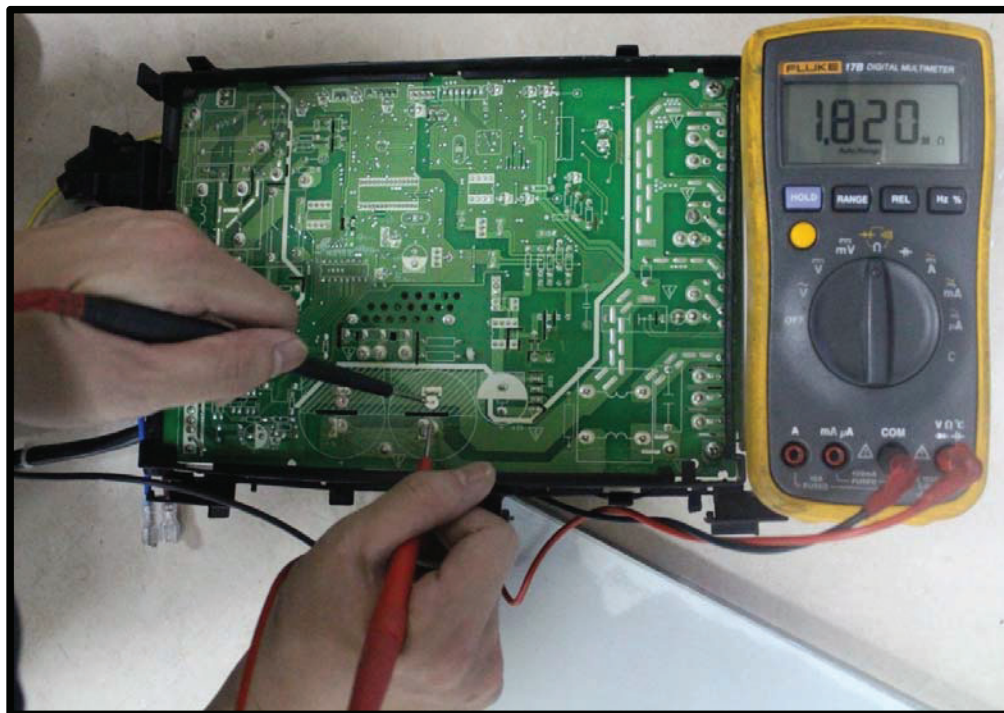
Fig. 37 – P-V

DIAGNOSIS AND SOLUTION (CONT.)



P-W

Fig. 38 – P-W



P-N

Fig. 39 – P-N

DIAGNOSIS AND SOLUTION (CONT.)

Over voltage or too low voltage protection diagnosis and solution (P1)

Error Code	P1
Malfunction decision conditions	An abnormal voltage rise or drop is detected by checking the specified voltage detection circuit.
Probable causes	<ul style="list-style-type: none"> • Power supply problems • System leakage or block • PCB faulty

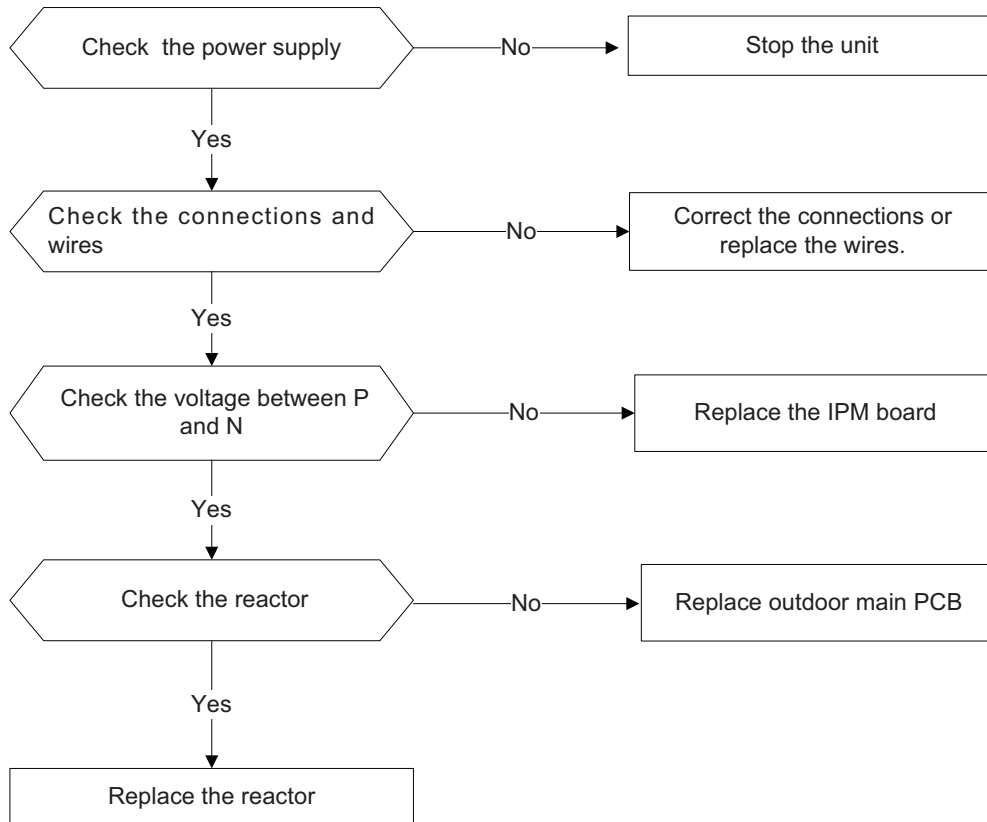
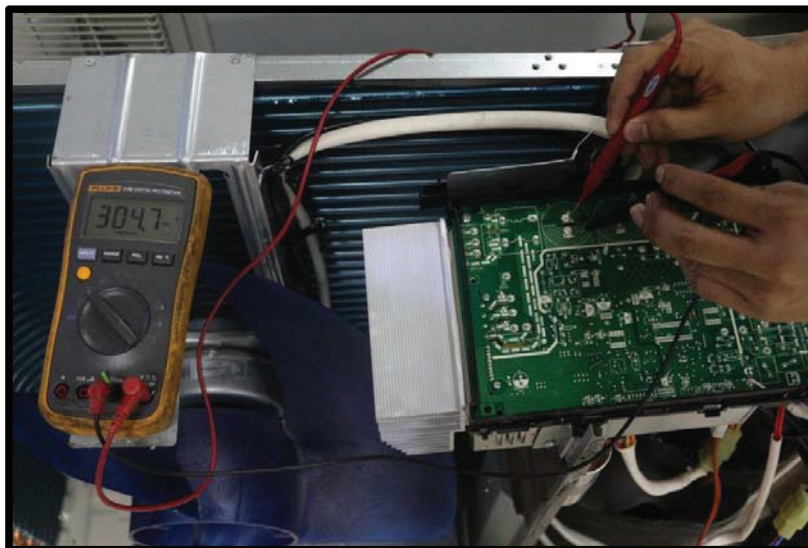


Fig. 40 – Troubleshooting



Remark:
 Measure the DC voltage between P and N port. The normal value should be around 310V.

Fig. 41 – Measure the DC voltage

DIAGNOSIS AND SOLUTION (CONT.)

High temperature protection of compressor top diagnosis and solution (P2)

Error Code	P2
Malfunction decision conditions	If the sampling voltage is not 5V, the LED displays the failure.
Probable causes	<ul style="list-style-type: none"> • Power supply problems • System leakage or block • Faulty PCB

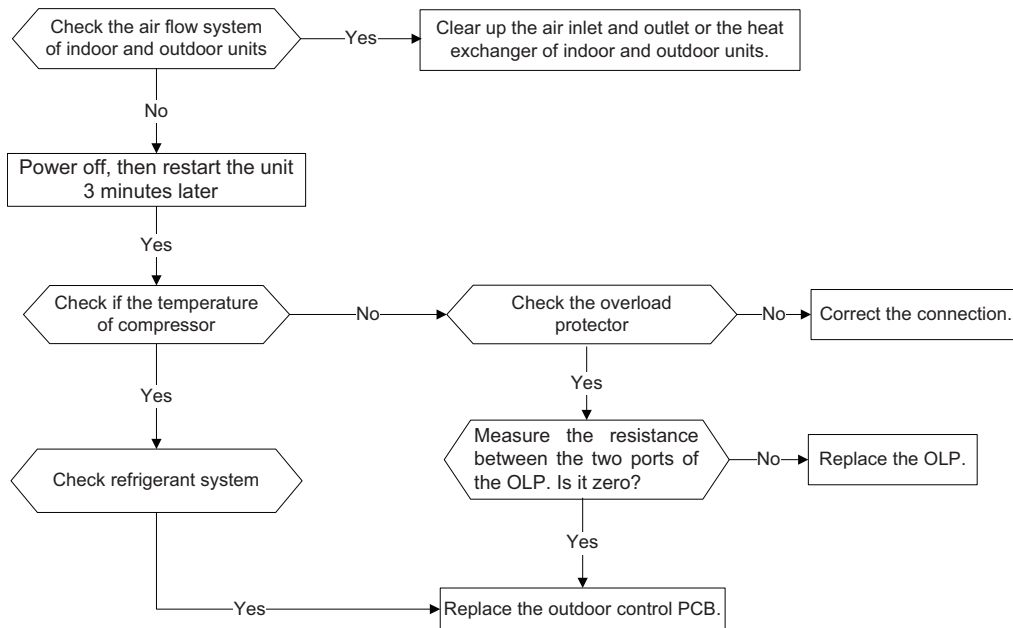


Fig. 42 – Troubleshooting

DIAGNOSIS AND SOLUTION (CONT.)

Inverter compressor drive error diagnosis and solution (P4)

Error Code	P4
Malfunction decision conditions	An abnormal inverter compressor drive is detected by a special detection circuit, including communication signal detection, voltage detection, compressor rotation speed signal detection.
Probable causes	<ul style="list-style-type: none"> • Wiring problem • IPM malfunction • Faulty outdoor fan assembly • Compressor malfunction • Faulty outdoor PCB

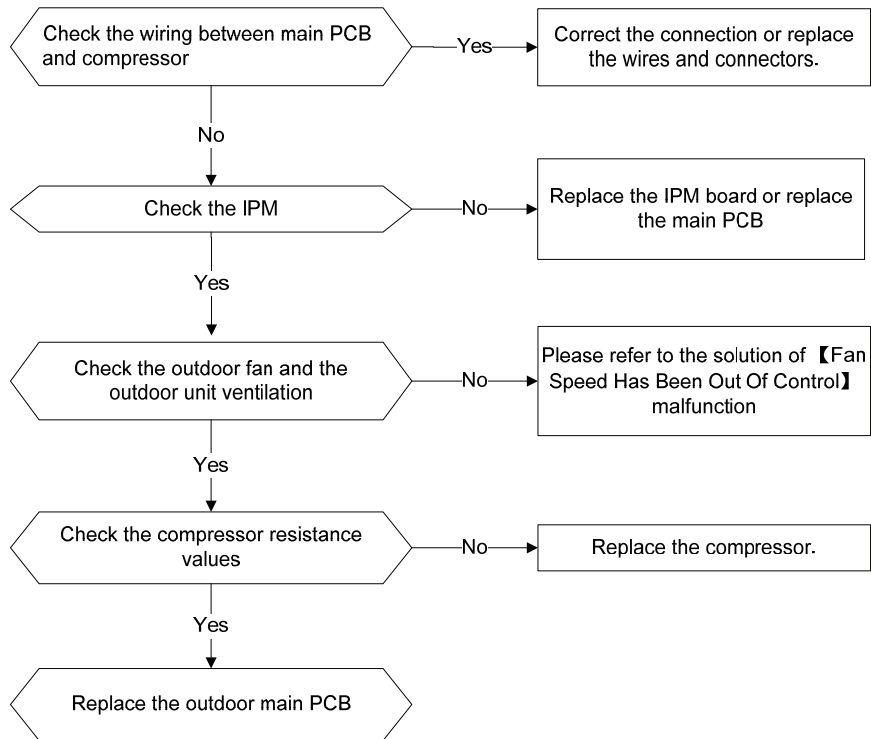
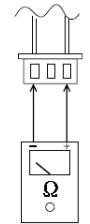


Fig. 43 – Troubleshooting

Main Parts Check

Temperature sensor checking

Disconnect the temperature sensor from PCB, measure the resistance value with a tester.



Tester

Fig. 44 – Tester

Temperature Sensors:

- Room temp.(T1) sensor
- Indoor coil temp.(T2) sensor
- Outdoor coil temp.(T3) sensor
- Outdoor ambient temp.(T4) sensor
- Compressor discharge temp.(T5) sensor

Measure the resistance value of each winding by using the multi-meter.

APPENDIX 1

Table 10— Temperature Sensor Resistance Value Table for T1,T2,T3,T4 (t---K)

°C	°F	K Ohm	°C	°F	K Ohm	°C	°F	K Ohm	°C	°F	K Ohm
-20	-4	115.266	20	68	12.6431	60	140	2.35774	100	212	0.62973
-19	-2	108.146	21	70	12.0561	61	142	2.27249	101	214	0.61148
-18	0	101.517	22	72	11.5	62	144	2.19073	102	216	0.59386
-17	1	96.3423	23	73	10.9731	63	145	2.11241	103	217	0.57683
-16	3	89.5865	24	75	10.4736	64	147	2.03732	104	219	0.56038
-15	5	84.219	25	77	10	65	149	1.96532	105	221	0.54448
-14	7	79.311	26	79	9.55074	66	151	1.89627	106	223	0.52912
-13	9	74.536	27	81	9.12445	67	153	1.83003	107	225	0.51426
-12	10	70.1698	28	82	8.71983	68	154	1.76647	108	226	0.49989
-11	12	66.0898	29	84	8.33566	69	156	1.70547	109	228	0.486
-10	14	62.2756	30	86	7.97078	70	158	1.64691	110	230	0.47256
-9	16	58.7079	31	88	7.62411	71	160	1.59068	111	232	0.45957
-8	18	56.3694	32	90	7.29464	72	162	1.53668	112	234	0.44699
-7	19	52.2438	33	91	6.98142	73	163	1.48481	113	235	0.43482
-6	21	49.3161	34	93	6.68355	74	165	1.43498	114	237	0.42304
-5	23	46.5725	35	95	6.40021	75	167	1.38703	115	239	0.41164
-4	25	44	36	97	6.13059	76	169	1.34105	116	241	0.4006
-3	27	41.5878	37	99	5.87359	77	171	1.29078	117	243	0.38991
-2	28	39.8239	38	100	5.62961	78	172	1.25423	118	244	0.37956
-1	30	37.1988	39	102	5.39689	79	174	1.2133	119	246	0.36954
0	32	35.2024	40	104	5.17519	80	176	1.17393	120	248	0.35982
1	34	33.3269	41	106	4.96392	81	178	1.13604	121	250	0.35042
2	36	31.5635	42	108	4.76253	82	180	1.09958	122	252	0.3413
3	37	29.9058	43	109	4.5705	83	181	1.06448	123	253	0.33246
4	39	28.3459	44	111	4.38736	84	183	1.03069	124	255	0.3239
5	41	26.8778	45	113	4.21263	85	185	0.99815	125	257	0.31559
6	43	25.4954	46	115	4.04589	86	187	0.96681	126	259	0.30754
7	45	24.1932	47	117	3.88673	87	189	0.93662	127	261	0.29974
8	46	22.5662	48	118	3.73476	88	190	0.90753	128	262	0.29216
9	48	21.8094	49	120	3.58962	89	192	0.8795	129	264	0.28482
10	50	20.7184	50	122	3.45097	90	194	0.85248	130	266	0.2777
11	52	19.6891	51	124	3.31847	91	196	0.82643	131	268	0.27078
12	54	18.7177	52	126	3.19183	92	198	0.80132	132	270	0.26408
13	55	17.8005	53	127	3.07075	93	199	0.77709	133	271	0.25757
14	57	16.9341	54	129	2.95896	94	201	0.75373	134	273	0.25125
15	59	16.1156	55	131	2.84421	95	203	0.73119	135	275	0.24512
16	61	15.3418	56	133	2.73823	96	205	0.70944	136	277	0.23916
17	63	14.6181	57	135	2.63682	97	207	0.68844	137	279	0.23338
18	64	13.918	58	136	2.53973	98	208	0.66818	138	280	0.22776
19	66	13.2631	59	138	2.44677	99	210	0.64862	139	282	0.22231

APPENDIX 2

Table 11— Temperature Sensor Resistance Value Table for T5 (t--K)

°C	°F	K Ohm	°C	°F	K Ohm	°C	°F	K Ohm	°C	°F	K Ohm
-20	-4	542.7	20	68	6866	60	140	13.59	100	212	3.702
-19	-2	511.9	21	70	6562	61	142	13.11	101	214	3.595
-18	0	483	22	72	6273	62	144	12.65	102	216	3.492
-17	1	455.9	23	73	5998	63	145	12.21	103	217	3.392
-16	3	430.5	24	75	5737	64	147	11.79	104	219	3.296
-15	5	406.7	25	77	5489	65	149	11.38	105	221	3.203
-14	7	384.3	26	79	5253	66	151	10.99	106	223	3.113
-13	9	363.3	27	81	5028	67	153	10.61	107	225	3.025
-12	10	343.6	28	82	4814	68	154	10.25	108	226	2.941
-11	12	325.1	29	84	4611	69	156	9.902	109	228	2.86
-10	14	307.7	30	86	4417	70	158	9.569	110	230	2.781
-9	16	291.3	31	88	4233	71	160	9.248	111	232	2.704
-8	18	275.9	32	90	4057	72	162	8.94	112	234	2.63
-7	19	261.4	33	91	3889	73	163	8.643	113	235	2.559
-6	21	247.8	34	93	373	74	165	8.358	114	237	2.489
-5	23	234.9	35	95	3578	75	167	8.084	115	239	2.422
-4	25	222.8	36	97	3432	76	169	7.82	116	241	2.357
-3	27	211.4	37	99	3294	77	171	7.566	117	243	2.294
-2	28	200.7	38	100	3162	78	172	7.321	118	244	2.233
-1	30	190.5	39	102	3036	79	174	7.086	119	246	2.174
0	32	180.9	40	104	2915	80	176	6.859	120	248	2.117
1	34	171.9	41	106	28	81	178	6.641	121	250	2.061
2	36	163.3	42	108	269	82	180	6.43	122	252	2.007
3	37	155.2	43	109	2586	83	181	6.228	123	253	1.955
4	39	147.6	44	111	2485	84	183	6.033	124	255	1.905
5	41	140.4	45	113	2389	85	185	5.844	125	257	1.856
6	43	133.5	46	115	2289	86	187	5.663	126	259	1.808
7	45	127.1	47	117	221	87	189	5.488	127	261	1.762
8	46	121	48	118	2126	88	190	5.32	128	262	1.717
9	48	115.2	49	120	2046	89	192	5.157	129	264	1.674
10	50	109.8	50	122	1969	90	194	5	130	266	1.632
11	52	104.6	51	124	1896	91	196	4.849			
12	54	99.69	52	126	1826	92	198	4.703			
13	55	95.05	53	127	1758	93	199	4.562			
14	57	90.66	54	129	1694	94	201	4.426			
15	59	86.49	55	131	1632	95	203	4.294			
16	61	82.54	56	133	1573	96	205	4.167			
17	63	78.79	57	135	1516	97	207	4.045			
18	64	75.24	58	136	1462	98	208	3.927			
19	66	71.86	59	138	1409	99	210	3.812			

IPM Continuity Check

Turn off the power, let the large capacity electrolytic capacitors discharge completely, and dismount the IPM. Use a digital tester to measure the resistance between P and UVWN; UVW and N.

Table 12— IPM Continuity Check

Digital Tester		Normal Resistance value	Digital Tester		Normal Resistance Value
(+) Red	(-) Black		(+) Red	(-) Black	
P	N	∞ (Several M W)	U	N	∞ (Several M W)
	U				
	V				
	W				
	W				
			(+) Red		

Pressure on Service Port

Table 13—Cooling Chart

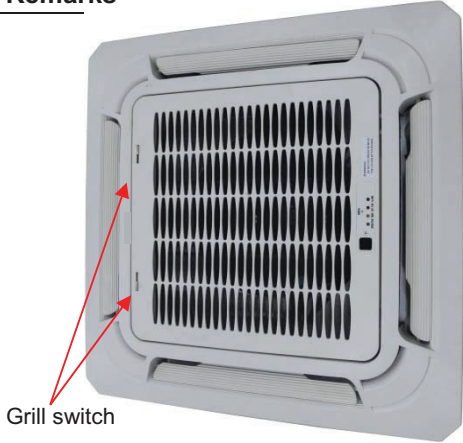

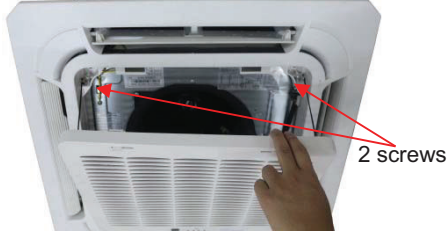
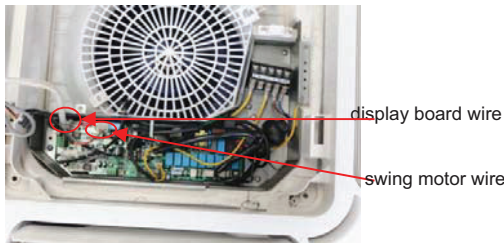
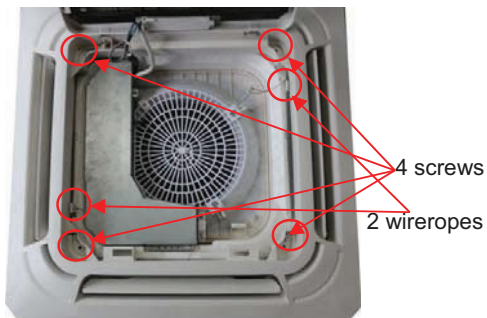

°F °C	Indoor Temp.	Outdoor Temp.				
		75 (23.89)	85 (29.44)	95 (35)	105 (40.56)	115 (46.11)
BAR	70	8.2	7.8	8.1	8.6	10.1
BAR	75	8.6	8.3	8.7	9.1	10.7
BAR	80	9.3	8.9	9.1	9.6	11.2
PSI	70	119	113	117	125	147
PSI	75	124	120	126	132	155
PSI	80	135	129	132	140	162
MPA	70	0.82	0.78	0.81	0.86	1.01
MPA	75	0.86	0.83	0.87	0.91	1.07
MPA	80	0.93	0.89	0.91	0.96	1.12

Heating Chart

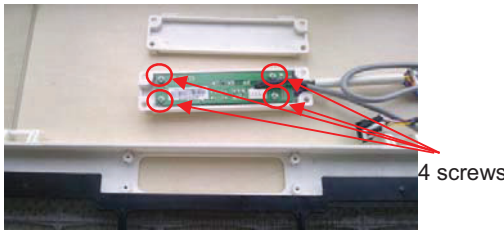

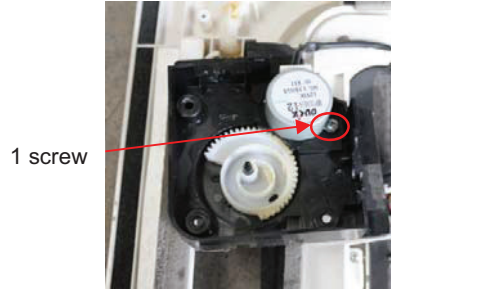
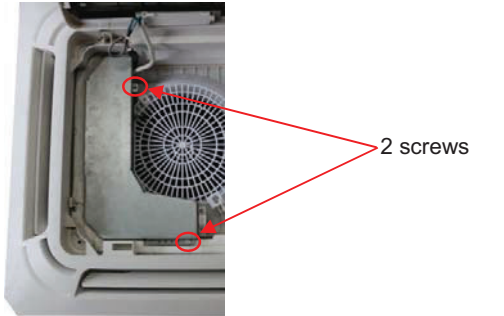
Table 14—Heating Chart

°F/°C	Indoor temp.	Outdoor Temperature				
		57 (13.89)	47 (8.33)	37 (2.78)	27 (−2.78)	17 (−8.33)
BAR	55	30.3	28.5	25.3	22.8	20.8
BAR	65	32.5	30.0	26.6	25.4	23.3
BAR	75	33.8	31.5	27.8	26.3	24.9
PSI	55	439	413	367	330	302
PSI	65	471	435	386	368	339
PSI	75	489	457	403	381	362
MPA	55	3.03	2.85	2.53	2.28	2.08
MPA	65	3.25	3.00	2.66	2.54	2.33
MPA	75	3.38	3.15	2.78	2.63	2.49

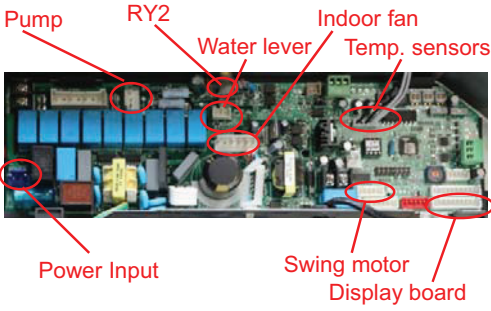


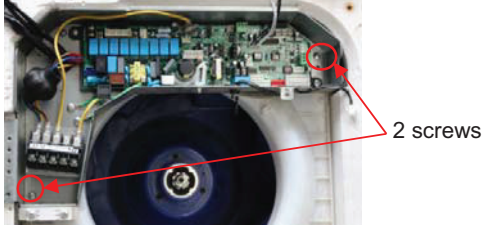
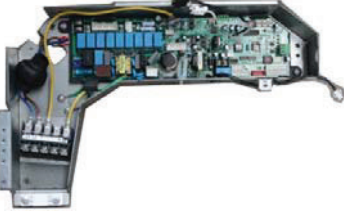
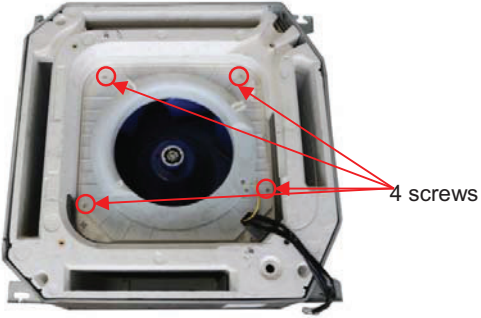
DISASSEMBLY INSTRUCTIONS

No.	Parts name	Procedures	Remarks
1	Remove the filter	1) Open the grille	 <p>Grill switch</p>
		2) Remove the filter Note: the filter is easy to be damaged, be careful when removing it.	
2	Remove the panel	1) Open the grille 2) Remove the grille <ul style="list-style-type: none"> ● Screw off two screws. ● Disconnect the display board wire and swing motor wire connected to the PCB. ● Remove the grille. 3) Loose the four screws and two wireropes, then the panel can be disassembled.	Repeat the operation of step1 of No.1   
3	Remove the display board	1) Open the grille 2) Remove the grille 3) Disassemble the display board <ul style="list-style-type: none"> ● Remove the display 	Repeat the operation of step1 of No.1 Repeat the operation of step2 of No.2  <p>4 screws</p>




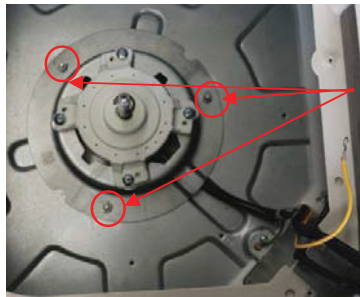
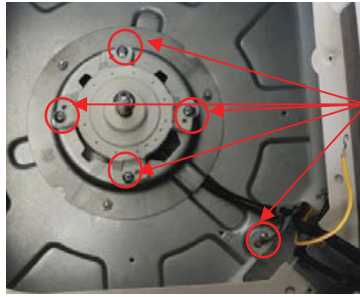
DISASSEMBLY INSTRUCTIONS (CONT.)

		<p>board cover(4 screws)</p> <ul style="list-style-type: none"> ● Remove the display board(4 screws) 	
4	Remove the swing motor	1) Remove the panel	Repeat the operation of step1,2,3 of No.2
		2) Unscrew the 3 screws to remove the swing motor assy.	
		3) Unscrew 1 screw to remove the swing motor.	
5	Remove the PCB	1) Open the grille	Repeat the operation of step1 of No.1(No need to remove the panel)
		2) Disassemble the electronic control box cover after remove the 2 screws.	

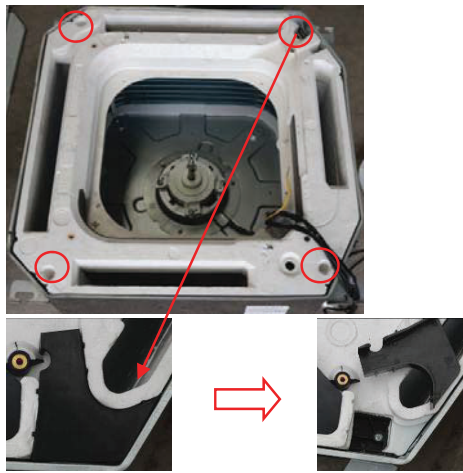
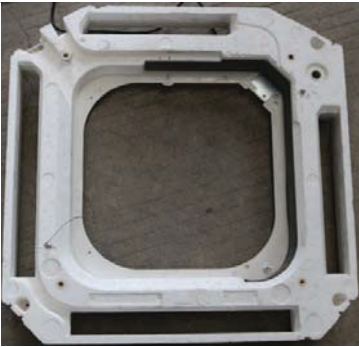
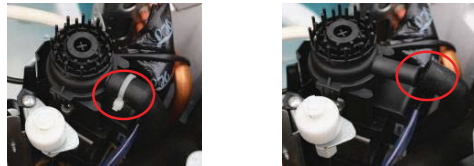
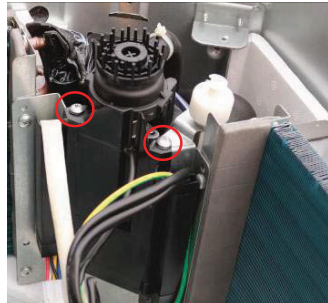
DISASSEMBLY INSTRUCTIONS (CONT.)

		3) Pull out all the connection wires to other parts, then the PCB can be replaced.	
		4) There are 2 buckles fixing the PCB. To draw out the PCB, you should open them.	
6	Remove the electronic control box	1) Open the grille	Repeat the operation of step1 of No.1(No need to take down the panel)
		2) Remove the electronic control box cover	Repeat the operation of step 2 of No.5
		3) Pull out all the plugs or connectors connected to the electronic control box	
		4) Remove the electronic control box Remove the 2 screws to disassemble the electronic control box	 
7	Remover the fan wheel	1) Repeat the operation of No.5	
		2) Remove the ventilation ring Release the 4 screws to disassemble it.	



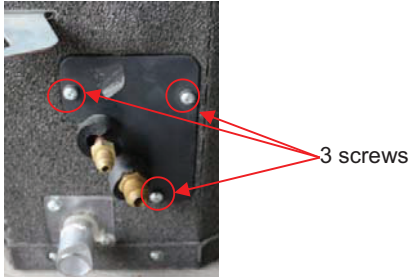
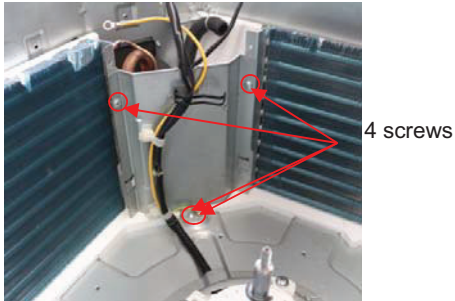
DISASSEMBLY INSTRUCTIONS (CONT.)

			
		3) Remove the fixing nut to disassemble the fan wheel	
		4) Pull out the fan wheel	
8	Remove the fan motor	1) Repeat the operation of No.6	
		2) Remove the fixing board of fan motor wire	
		3) Remove the 5 screws to disassemble the fan motor	

DISASSEMBLY INSTRUCTIONS (CONT.)

9	Remove the water collecting assembly	1) Remove the panel	Repeat the operation of No.2
		2) Remove the electronic control box	Repeat the operation of No.6
		3) Unscrew the 4 screws inside the 4 holes (1 is under a protection cover) to remove the water collecting assembly.	
		4) Take out the water collecting assembly	
10	Remove the draining pump	1) Remove the panel	Repeat the operation of No.2
		2) Remove the electronic control box	Repeat the operation of No.6
		3) Remove the water collecting assembly	Repeat the operation of No.9
		4) Disconnect the drain pipe.	
		5) Remove 2 screws to remove the pump supporter. Be careful of the connection wires.	

DISASSEMBLY INSTRUCTIONS (CONT.)

			
		<p>6) There are 2 screws under the supporter to fixing the pump. Release them to take the pump out of the supporter.</p>	
11	Remove the evaporator	<p>1) Remove the water collecting assembly</p>	<p>Repeat the operation of No.9</p>
<p>2) Remove the seal board of evaporator</p>			
<p>3) Remove the evaporator fixing board</p>			
<p>4) Remove the evaporator fixing clamps to disassemble the evaporator.</p>		