

Comfort Alert

CADM Troubleshooting

Comfort Alert – LED Fault Codes

- System Pressure Trip (Code 2)
- Short Cycling (Code 3)
- Locked Rotor (Code 4)
- Open Circuit (Code 5)
- Missing Phase (Code 6)
- Reverse Phase 3 Φ (Code 7)
- Welded Contactor (Code 8)
- Low Voltage (Code 9)

Comfort Alert Connections

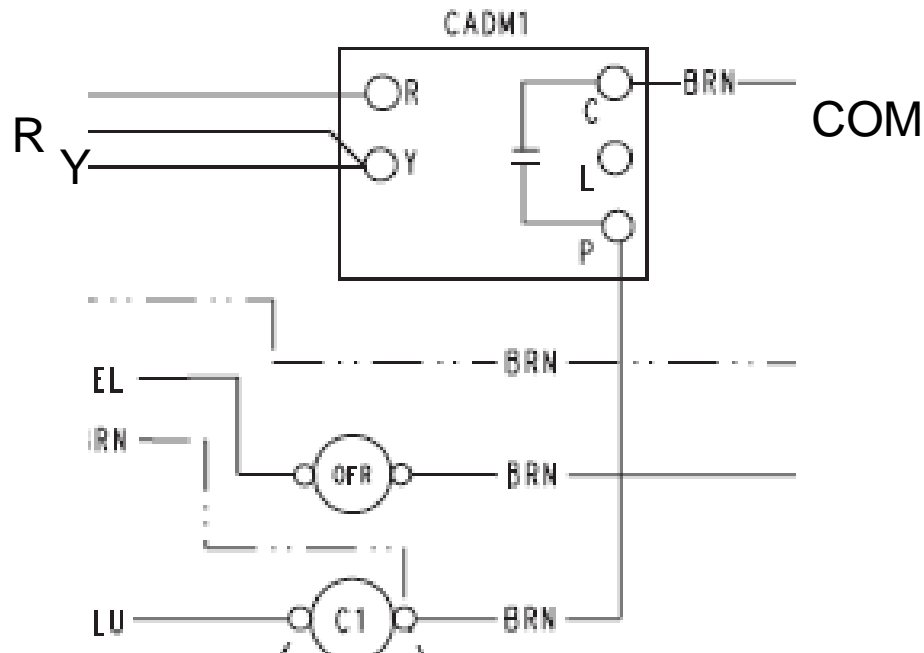
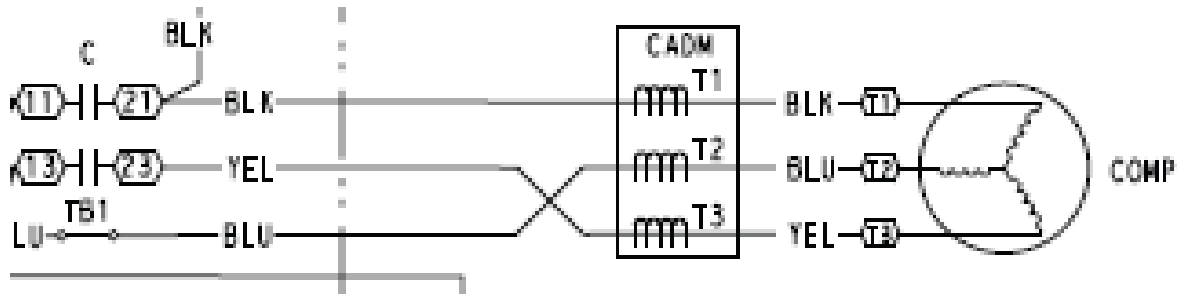

Sensing Motor Protector Trips

- **Comfort Alert Detects A Motor Trip When:**
 - Thermostat Demand “Y” Is On
 - No Current Is Measured To Compressor
- **Interpretation: Compressor Isn’t Operating When System Demand Is Present**
- **Root Causes**
 - LPS, HPS Open
 - Motor Protector Open
 - Power Disconnected (Fuse, Switch, Etc.)
 - Comfort Alert Not Wired Properly

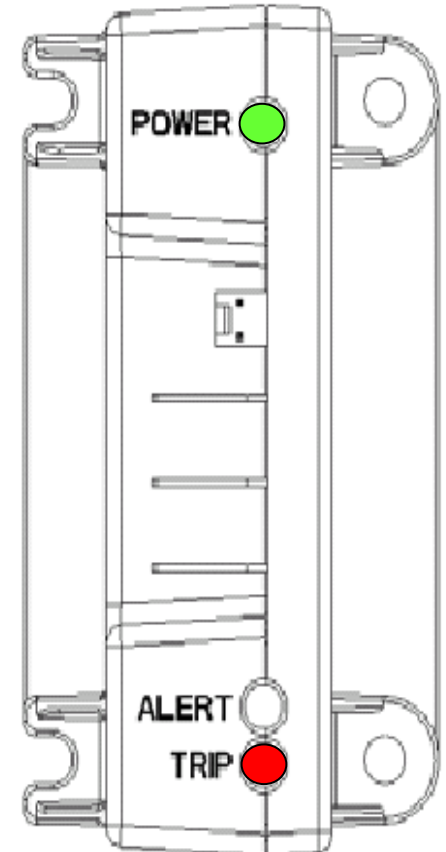

Sensing System Pressure Trip Code 2

- **Comfort Alert Detects System Pressure Code When:**
 - Four Consecutive Protector Trips Occur
 - The Average Run Until Trip Time Is Between 1 Minute And 15 Minutes
- **Interpretation: High Pressure Condition Causes Compressor To Run Briefly Before Tripping**
- **Root Causes**
 - Blocked Condenser Coils
 - Condenser Fan Not Running
 - LPS

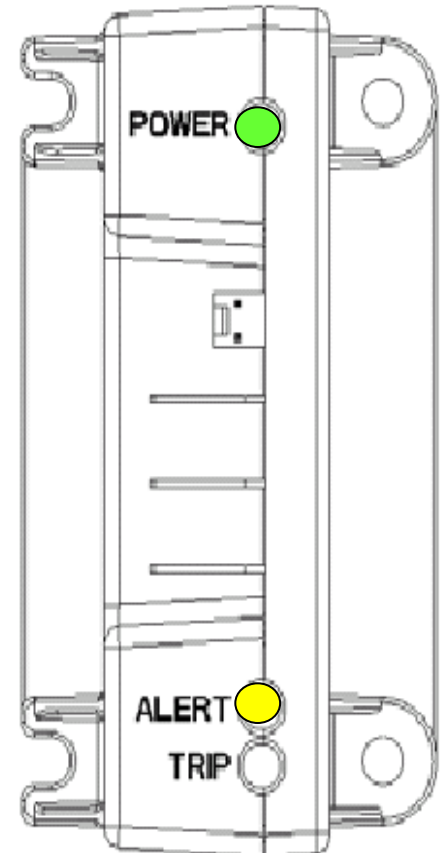

Sensing Short Cycling Code 3

- **Comfort Alert Detects Short Cycling Code When:**
 - A Pattern Of Short Cycles Emerges
 - Average Run Time For Past 4 Runs Is Less Than 3 Minutes
 - Normal End-of-Cycle (Y Input Removed)
- **Interpretation: Compressor Is Running Only Short Periods Of Time**
- **Root Causes**
 - Low Space Load
 - Faulty Thermostat

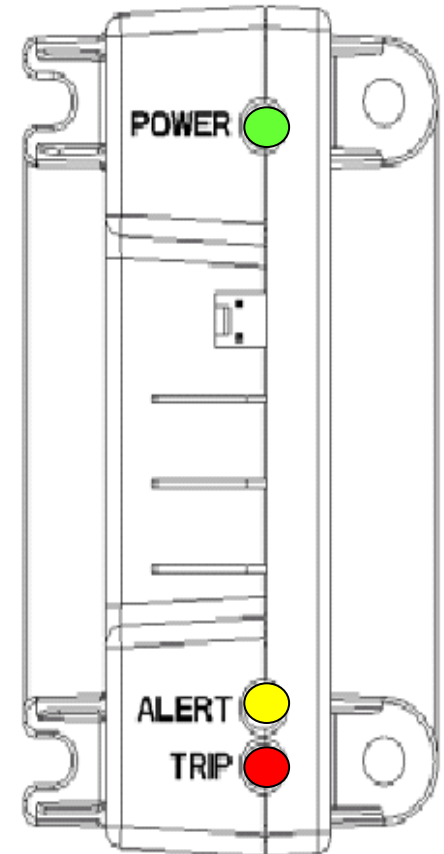

Sensing Locked Rotor Code 4

- **Comfort Alert Detects Locked Rotor Code When:**
 - Four Consecutive Protector Trips Occur
 - Y Demand Is Constant, Uninterrupted
 - The Average Run Until Trip Time Is Less Than 15 Seconds
- **Interpretation: Compressor Is Attempting To Start But Cannot**
- **Root Causes**
 - Low Line Voltage
 - Mechanical Issue With Compressor

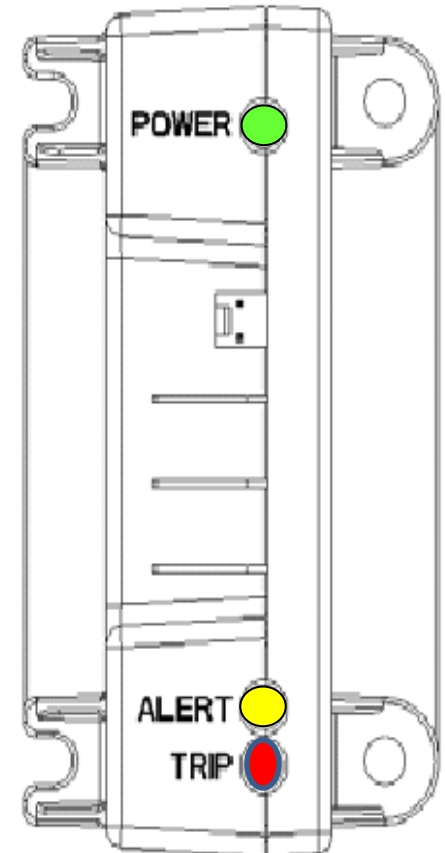

Sensing Open Circuit Code 5

- **Comfort Alert Detects A Open Circuit Code When:**
 - Y Present, No Compressor Current For More Than 4 Hours (Protector Trip)
- **Interpretation: Power Is Not Connected To Compressor**
- **Root Causes**
 - Power Disconnected (Fuse, Switch, Etc.)
 - Failed Compressor Protector
 - Comfort Alert Not Wired Properly
 - Motor Leads Not Routed Through Comfort Alert Current Sensors

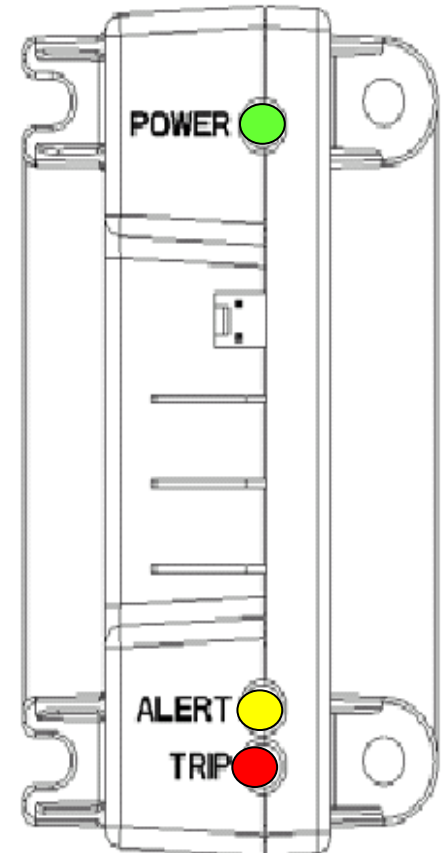

Sensing Missing Phase Code 6

- **Comfort Alert Detects A Code 6 When There is Power to Y or Y1 and:**
 - Time Frequency between T1 and T3 is within certain parameters depending on 50 or 60 Hz power supply when T2 is missing
 - Either T1 or T3 Does Not Detect Current
 - Both Events Have To Last One Second
- **Interpretation: One Winding Of Compressor Not Getting Power**
- **Root Causes**
 - Blown Fuse
 - Loose Or Broken Wires
 - Compressor Winding Damage

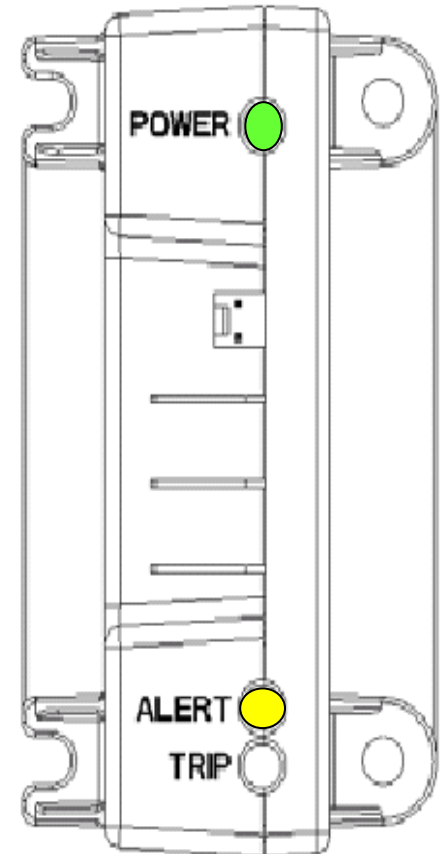

Sensing Reverse Phase Code 7

- **Comfort Alert Detects A Code 7 When There is Power to Y or Y1 and:**
 - Time Frequency between T1 and T3 is within certain parameters depending on 50 or 60 Hz power supply for 1 Second. This Time Parameter is Different from Code 6.
- **Interpretation: Two of the Phases are Reversed**
- **Root Causes**
 - Supply Power Leads Not Routed Correctly
 - From Power Source To Compressor

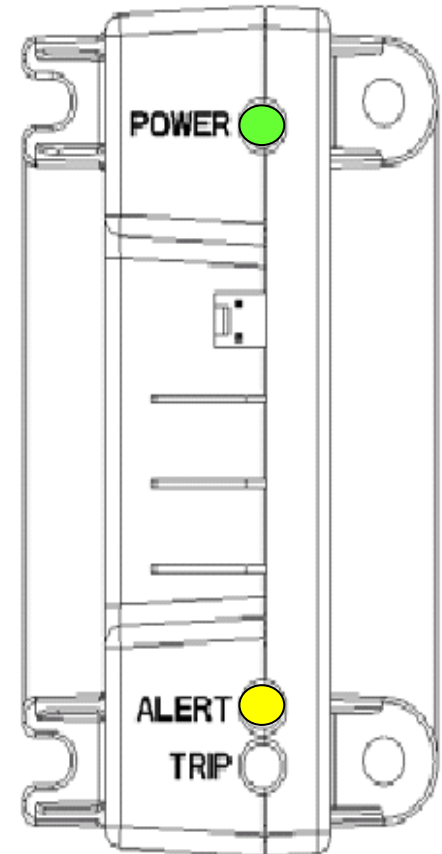

Sensing Welded Contactor Code 8

- **Comfort Alert Detects A Welded Contactor Code When:**
 - Current Is Detected Without “Y” Input
- **Interpretation: Compressor Contactor Will Not Disengage**
- **Root Causes**
 - Welded Contactor
 - Comfort Alert Not Wired Properly
 - Demand Wire Bypassing Comfort Alert Module

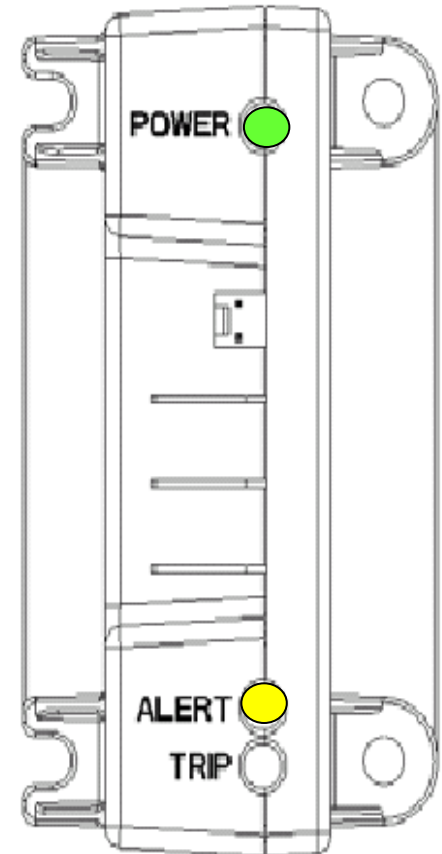

Sensing Low Voltage Code 9

- **Comfort Alert Detects Low Voltage Code When:**
 - Comfort Alert 24VAC Is Below 18VAC
- **Interpretation: Low Voltage Condition Exists**
- **Root Causes**
 - Control Transformer Overloaded
 - Line Voltage Low

Auto-reset at 19 VAC
3-Minute Recheck

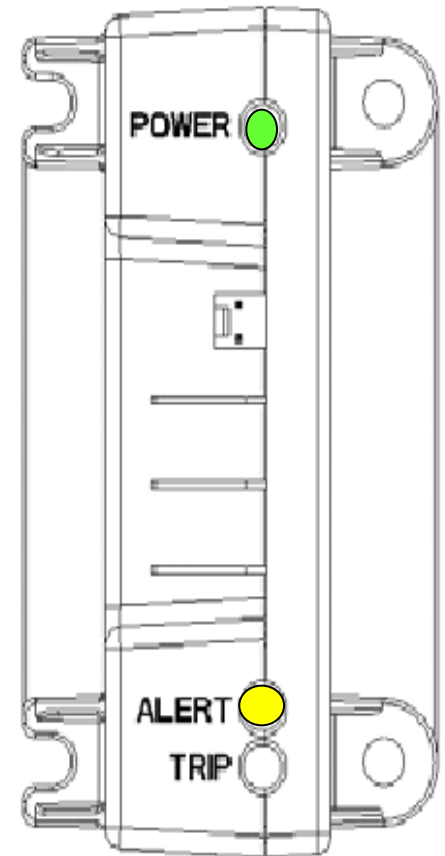

Multiple Alerts Condition

- **If Multiple Alerts Occur, Comfort Alert Displays The First Code That Is Detected**
 - **Allows Technician To Determine The Root Cause**
- **Example**
 - **Low Line Voltage Leads To Locked Rotor Condition On Compressor**
 - **Comfort Alert Displays Low Voltage Code Even While Locked Rotor Events Are Happening**
- **Protective codes (2,3,4,6,7,9) have Precedence over Non Protective Codes**
- **Over Current Sensed at Comfort Alert P-Terminal (1.5 +/-0.5 Amps) takes Precedence over Protective Code**

CADM Resets

- **Automatic Reset**
 - **Voltage Alert (Code 9) Resets When Voltage Rises Above 19VAC**
- **Manual Reset**
 - **All Alert Codes Can Be Reset By Cycling 24VAC Power**
 - **Previous Code Will Flash 60 Seconds**

CADM Memory

- **Comfort Alert Displays Last Alarm At Each Power Up**
 - Displays Code If Alarm Occurred During Last Power Cycle
 - Display Lasts For One Minute
- **Alarm History Is Kept In Memory**
 - Comfort Alert Analysis Software Required
 - Seven Day History Of Alarms
 - Overall Count Of Alarms In Permanent History
- **Anti Short Cycle Timer**
 - 3 Minute Off Cycle after normal Shutdown
 - Time Delay not Active First 50 Starts
 - RED LED Flashes during OFF Period

Table 12 — LED Status Codes

Status LED	Status LED Description	Status LED Troubleshooting Information
Green "POWER"	Module has power	Supply voltage is present at module terminals
Red "TRIP" LED On Solid	Thermostat demand signal Y is present, but the compressor is not running.	<ol style="list-style-type: none"> 1. Compressor protector is open 2. Condensing unit power disconnect is open 3. Compressor circuit breaker or fuse(s) is open 4. Broken supply wires or connector is not making contact 5. Compressor power wires not routed through Comfort Alert 6. Compressor contactor has failed open
Red "TRIP" LED Flashing	The anti-short cycle timer (3 minutes), in module is preventing compressor restart.	
Module locks out compressor when compressor damaging ALERT code appears. Lockout ALERT codes are noted in the Status LED Description. During a compressor lock out, 24VAC power must be removed from module to manually reset.		
Yellow "ALERT" LED On Solid	A short circuit or over current condition exists on PROT terminal.	<ol style="list-style-type: none"> 1. Compressor contactor coil shorted 2. Electrical load too high for PROT circuit (maximum 1 Amp) 3. 24 V AC wired directly to PROT terminal
Yellow "ALERT" Flash Code 2	System Pressure Trip Discharge pressure out of limits or compressor overload (if no high pressure switch in system) LOCKOUT	<ol style="list-style-type: none"> 1. High head pressure 2. Condenser coil poor air circulation (dirty, blocked, damaged) 3. Condenser fan is not running 4. If low pressure switch is open: Refer to Code 3 for troubleshooting

Yellow "ALERT" Flash Code 3	Short Cycling Compressor is running only briefly LOCKOUT	<ol style="list-style-type: none"> 1. If low pressure switch is open: <ol style="list-style-type: none"> a. Low refrigerant charge b. Evaporator blower is not running c. Evaporator coil is frozen d. Faulty metering device e. Condenser coil is dirty f. Liquid line restriction (filter drier blocked if present) 2. If high pressure switch is open, go to Flash Code 2 information 3. Intermittent thermostat demand signal 4. System or control board defective
Yellow "ALERT" Flash Code 4	Locked Rotor LOCKOUT	<ol style="list-style-type: none"> 1. Low line voltage to compressor 2. Excessive liquid refrigerant in compressor 3. Compressor bearings are seized
Yellow "ALERT" Flash Code 5	Open Circuit	<ol style="list-style-type: none"> 1. Condensing unit power disconnect is open 2. Compressor circuit breaker or fuses are open 3. Compressor contactor has failed open 4. High pressure switch is open and requires manual reset 5. Broken supply wires or connector is not making contact 6. Unusually long compressor protector reset time due to extreme ambient temperature 7. Compressor windings are damaged
Yellow "ALERT" Flash Code 6	Missing Phase LOCKOUT	<ol style="list-style-type: none"> 1. Compressor fuse is open on one phase 2. Broken wire or connector on one phase 3. Compressor motor winding is damaged 4. Utility supply has dropped one phase
Yellow "ALERT" Flash Code 7	Reverse Phase LOCKOUT	<ol style="list-style-type: none"> 1. Compressor running backward due to supply phase reversal
Yellow "ALERT" Flash Code 8	Welded Contactor Compressor always runs	<ol style="list-style-type: none"> 1. Compressor contactor has failed closed 2. Thermostat demand signal not connected to module
Yellow "ALERT" Flash Code 9	Low Voltage Control circuit < 18VAC	<ol style="list-style-type: none"> 1. Control circuit transformer is overloaded 2. Low line voltage to compressor

Table 13 — CADM Troubleshooting

Miswired Module Indication	Recommended Troubleshooting Action
Green LED is not on, module does not power up	<p>Determine if both R and C module terminals are connected. Verify voltage is present at module's R and C terminals.</p> <p>NOTE: The CADM requires a constant nominal 24VAC power supply. The wiring to the module's R and C terminals must be directly from the control transformer. The module cannot receive its power from another device that will interrupt the 24VAC power supply. See Fig. 26 and (38AUZ Wiring Diagram) and Fig. 27 (38AUD Wiring Diagram).</p>
Green LED Intermittent, module powers up only when compressor runs	<p>Determine if R and Y terminals are wired in reverse. Verify module's R and C terminals have a constant source. See "NOTE" above for details on R and C wiring.</p>
TRIP LED is on but system and compressor check OK	<p>Verify Y terminal is wired properly per the 38AU wiring diagram (see Figs. 26 and 27). Verify voltage at contactor coil falls below 0.5VAC when off. Verify 24VAC is present across Y and C when thermostat demand signal is present. If not, R and C are reverse wired.</p>
TRIP LED and ALERT LED flashing together	<p>Verify R and C terminals are supplied with 19-28VAC.</p>
ALERT Flash Code 3 (Compressor Short Cycling) displayed incorrectly	<p>Verify Y terminal is connected to 24VAC at contactor coil. Verify voltage at contactor coil falls below 0.5VAC when off.</p>
ALERT Flash Code 5 or 6 (Open Circuit, Missing Phase) displayed incorrectly	<p>Check that compressor T1 and T3 wires are through module's current sensing holes. Verify Y terminal is connected to 24VAC at contactor coil. Verify voltage at contactor coil falls below 0.5VAC when off.</p>
Alert Flash Code * (Welded Contactor) displayed incorrectly	<p>Determine if module's Y terminal is connected. Verify Y terminal is connected to 24VAC at contactor coil. Verify 24VAC is present across Y and C when thermostat demand signal is present. If not, R and C are reverse wired. Verify voltage at contactor coil falls below 0.5VAC when off.</p>