

SIEMENS

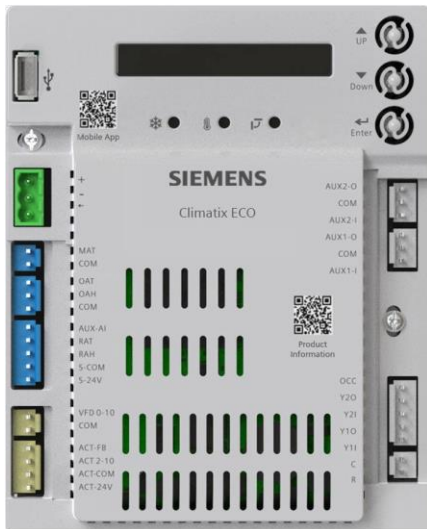

POL224.00, POL224.05

Climatix ECO

Application Guide

Table of Contents

1	About This User Guide	5
1.1	Revision History	5
1.2	Reference Documents	5
1.3	Before Starting	6
1.4	Pre-Installation Steps	6
1.4.1	Siemens Climatix Mobile App	6
1.4.2	Siemens POL903.00/100 WLAN Stick	6
1.4.3	Controller Password	7
2	Summary	8
2.1	Product Description	8
2.2	Features	8
2.3	Type Summary	8
3	Mounting, Installation and Wiring	9
3.1	Mounting the Economizer Controller Base Module	9
3.2	Mounting Devices Connected to the Economizer Controller	9
3.3	Wiring	10
3.3.1	Economizer Controller Wiring	10
3.3.2	Connecting Peripheral Devices to the Economizer Controller	12
3.3.3	Wiring Application Examples	14
4	Interface Overview	15
4.1	Powering the Economizer Controller	15
4.2	LED Indication	15
4.3	User Interface	16
4.4	Menu Structure	17
5	Functions	18
5.1	Free Cooling Economizing	18
5.2	Location-based Shutoff Setpoints	19
5.3	Cooling Stage Operation	20
5.4	Multi-Speed Fan Support	21
5.5	Variable-Speed Fan Support	24
5.6	Cooling Delay via Increasing Fan Speed	26
5.7	Demand Control Ventilation (DCV)	26
5.8	Free Cooling Shutdown	27
5.9	Anti-Freeze Protection	27
5.9.1	MAT-based Anti-Freeze Protection	27
5.9.2	OAT-based Anti-Freeze Protection	28
5.10	Exhaust Fan Operation	28
5.11	Occupancy Input	29
5.12	Pre-Occupancy Purge	29
5.13	Airflow Commissioning	29
5.14	Dehumidification	30
5.15	Energy Recovery Ventilation (ERV)	30
5.16	Fault Detection and Diagnostics	30

5.17	Firmware Update.....	31
6	Setup and Configuration	32
6.1	Status Display	32
6.2	Basic Settings.....	34
6.3	Advanced Settings	36
6.4	Alarms	37
6.5	Enter Configuration State and Restart	38
6.6	I/O Configuration	38
6.7	Test	40
6.8	Enter Running State.....	41
7	Sequence of Operation (Examples).....	42
8	Troubleshooting.....	45
9	Appendix A: Modbus Addresses.....	47
10	Appendix B: QFM2160U Graphs.....	50
11	Appendix C: QFR/QAR9530 Graphs.....	51

1 About This User Guide

1.1 Revision History

Edition	Date	Changes
3	May 2022	<ul style="list-style-type: none"> Updated LED description Updated descriptions of different functions Removed High Humidity Limitation Added the Free Cooling Shutdown function
2	March 2022	<ul style="list-style-type: none"> Added Pre-Installation Steps, Appendix B & C Added information about W1, O/B in tables in Section 5.4 Changed default fan status when there is no cooling demand Changed parameter default values
1	July 2021	First edition

1.2 Reference Documents

Ref.	Document description	Document number
[1]	POL224.00/POL224.05 Mounting Instructions	A6V11997548
[2]	POL224.00/POL224.05 Datasheet	A6V11681604
[3]	GQD151.1P Mounting Instructions	129-504
[4]	GMA151.1P Mounting Instructions	129-307
[5]	GCA151.1P Mounting Instructions	129-404
[6]	QPA2000 Mounting Instructions	129-435
[7]	QFM2160U Mounting Instructions	129-413
[8]	QFM2160U Datasheet	155-748
[9]	QFR9530, QAR9530, QFR9500 Mounting Instructions	A6V11937904
[10]	QFR9530, QAR9530, QFR9500 Datasheet	A6V11937911
[11]	QAM2030.010 Mounting Instructions	129-463
[12]	RDS120 Mounting Instructions	A6V10733793
[13]	RDY2000 Mounting Instructions	129-905
[14]	POL903.00/100 WLAN Stick	CC1N7219

You can download the above documents from [Siemens US Download Center](#) by searching the document numbers listed above.

1.3 Before Starting

This document may be duplicated and distributed only with the express permission of Siemens.

It is important to read the documents supplied with or ordered at the same time as the products (equipment, applications, tools, and so on) carefully and in full. Please direct any comments regarding this document to sbt_technical.editor.us.sbt@siemens.com.

Siemens assumes no liability to the extent allowed under the law for any losses resulting from a failure to comply with the aforementioned points or for the improper compliance of the same.

1.4 Pre-Installation Steps

1.4.1 Siemens Climatix Mobile App

To take advantage of the pre-configuration tools by utilizing the Climatix Mobile App, download the Climatix Mobile Application by utilizing the QR codes below.

iOS:



Android:



Note: Start the mobile application before connecting WLAN stick to the Economizer Controller. This will utilize the GPS location function on your smart phone to load the correct tables and presets for your zone.

1.4.2 Siemens POL903.00/100 WLAN Stick

Note: This item is sold separately and will be required to utilize the Climatix Mobile application.

This device is used to create a temporary wireless connection between the controller and mobile phone.

Connect the WLAN stick to a USB port. Wait until the LED flashes green. The connection between the terminal unit (notebook, cell phone, etc.) and the WLAN network (SSID "Siemens-WLAN-Stick") is established.

Relevant data for WLAN commissioning:

- SSID: Siemens-WLAN-Stick
- Password: SIBPAdmin
- DNS name: siemens.wlanstick

Siemens AG recommends changing the password as part of the commissioning process. Changes to all settings can be made via the web interface as required.

1.4.3 Controller Password

Relevant data for POL224.00 Economizer commissioning:

- Username: Administrator
- Initial Password: OneBT
- Once logged in to the controller, a password change will be required to proceed with the commissioning process.

2 Summary

2.1 Product Description

The Economizer Controller works in combination with a range of peripheral devices such as sensors, damper actuators, thermostat, fans and compressors to cool a building using unconditioned outside air and improve inside air quality. By switching to outside fresh air and reducing mechanical cooling, it saves energy and extends the lifespan of peripheral devices.

2.2 Features

- **Free cooling** based on single or dual dry bulb temperature, or combination temperature + humidity sensors
- Automatic switch-over for different control modes
- Parameter settings based on climate zone, using GPS functionality in the Climatix Mobile application
- LED indication for free cooling operation, sensor operation and damper operation
- Quick installation and easy commissioning with Climatix Mobile application
- User Interface for normal operation, parameter setup and alarm notifications with an LCD display and three operation buttons
- RS485 port for BACnet MSTP slave or Modbus RTU slave communication
- USB interface for firmware updates and WLAN connection
- QR codes for quick access to download Climatix Mobile application and user documentation
- Flexible sensor inputs accept Type II NTC 10K or 0-10 Vdc standard sensors, or Siemens QFM2160U or QFR9530 combination temperature/humidity sensor for enthalpy control
- Can be used with Siemens OpenAir® damper actuator GQD, GMA or GCA series
- 24Vac digital inputs for indication of occupancy, 3-stage Cooling Stage input, Shutdown, Heat Conventional, Heat Pump Changeover (HP(B)/HP(O)) or Preoccupancy
- 24Vac relay outputs (digital) for 3-stage Cooling Stage output, Exhaust Fan, VFD On/Off (Variable Speed Supply Fan Enable), System Alarm output (Title 24) or Energy Recovery Ventilation (ERV)
- Anti-freeze protection
- Fault detection and alarming
- Brownout protection

2.3 Type Summary

Type	Order number	Description
POL224.00	S55392-C202-A100	POL224.00 Title24 Economizer Controller
POL224.05	S55392-C203-A100	POL224.05 Title24 Econ Cont, no housing

3 Mounting, Installation and Wiring

3.1 Mounting the Economizer Controller Base Module

Before mounting, leave specific mounting clearances so that there is space for mounting, wiring and servicing.

POL224.00 and POL224.05 can be mounted to sheet metal. Use two No. 6 3/4" self-tapping screws to mount POL224.00 and four screws and spacers to mount POL224.05. Order screws and spacers separately as they are not provided with the products.

See doc [A6V11997548](#) for detailed clearance requirements and graphical mounting instructions.

3.2 Mounting Devices Connected to the Economizer Controller

Devices like damper actuators, sensors (temperature sensor, humidity sensor, combination temperature and humidity sensor, CO₂ sensor), thermostats and exhaust fans can be connected to the Economizer Controller. For information about how to mount the devices, see the detailed mounting instructions in the documentation of the corresponding device listed in Reference Documents [→ 5].

3.3 Wiring

NOTICE



Illustrations in this whole section take POL224.00 as examples. POL224.00 and POL224.05 share the same terminal names and positions.

3.3.1 Economizer Controller Wiring

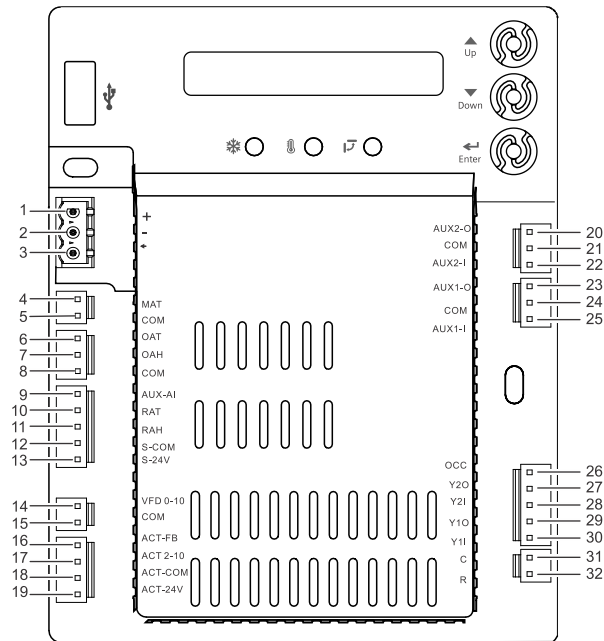

No.	Label	Type	Description
1	+	RS485 Modbus A	Line A
2	-	RS485 Modbus B	Line B
3	←	GND_ISO	Earth ground
4	MAT	Type II NTC 10K or 0-10 Vdc	Mixed or Discharge Air Temperature Sensor
5	COM	COM	Mixed or Discharge Air Temperature Sensor Common
6	OAT	Type II NTC 10K or 0-10 Vdc	Outside Air Temperature Sensor
7	OAH	0-10 Vdc or 4-20 mA	Outside Air Relative Humidity Sensor
8	COM	COM	Outside Air Temperature Sensor or Outside Air Relative Humidity Sensor Common
9	AUX-AI	0-10 Vdc, 2-10 Vdc or 0-5 Vdc	Air Quality Sensor or Pressure Sensor
10	RAT	Type II NTC 10K or 0-10 Vdc	Return Air Temperature Sensor
11	RAH	0-10 Vdc or 4-20 mA	Return Air Relative Humidity Sensor
12	S-COM	COM	24 Vac Common
13	S-24V	24 Vac	24 Vac Power out to sensors

No.	Label	Type	Description
14	VFD 0-10	0-10 Vdc	Variable-Speed Supply Fan Output
15	COM	COM	Variable-Speed Fan Output Common
16	ACT-FB	2-10 Vdc	Damper Actuator Feedback
17	ACT2-10	2-10 Vdc	Damper Actuator Output
18	ACT-COM	COM	Damper Actuator Output Common
19	ACT-24V	24 Vac	24 Vac Power out to Damper Actuator
20	AUX2-O	24 Vac OUT	Configurable: <ul style="list-style-type: none"> • Cooling Stage 3 Output • Exhaust Fan (1 or 2) • VFD On/Off (Variable Speed Supply Fan Enable or Disable) • ERV • System Alarm output (Title 24)
21	COM	COM	24 Vac Common
22	AUX2-I	24 Vac IN	Configurable: <ul style="list-style-type: none"> • Cooling Stage 3 Input • Shut Down • Heat Conventional (W1) • Heat Pump Changeover (reversing valve O/B, HP(B)/HP(O)) • Preoccupancy
23	AUX1-O	24 Vac OUT	Configurable: <ul style="list-style-type: none"> • Cooling Stage 3 Output • Exhaust Fan (1 or 2) • VFD On/Off (Variable Speed Supply Fan Enable or Disable) • ERV • System Alarm output (Title 24)
24	COM	COM	24 Vac Common
25	AUX1-I	24 Vac IN	Configurable: <ul style="list-style-type: none"> • Cooling Stage 3 Input • Shut Down • Heat Conventional (W1) • Heat Pump Changeover (reversing valve O/B, HP(B)/HP(O)) • Preoccupancy
26	OCC	24 Vac IN	Occupancy input <ul style="list-style-type: none"> • T-STAT • ALWAYS
27	Y2O	24 Vac OUT	Cooling Stage 2 Output to stage 2 mechanical cooling
28	Y2I	24 Vac IN	Cooling Stage 2 Input from commercial thermostat
29	Y1O	24 Vac OUT	Cooling Stage 1 Output to stage 1 mechanical cooling

No.	Label	Type	Description
30	Y1I	24 Vac IN	Cooling Stage 1 Input from commercial thermostat
31	C	COM	24 Vac Common
32	R	24 Vac	24 Vac Power

3.3.2 Connecting Peripheral Devices to the Economizer Controller

Temperature Sensor Connection

- Outside Air: Connect to the OAT and COM terminals of the device.
- Return Air (Differential): Connect to the RAT and COM terminals of the device.
- Mixed Air: Connect to the MAT and COM terminals of the device.

Mixed or Discharge Air Temperature Sensor QAM2030.010 or QAR9530

Outside Air Temperature Sensor QAM2030.010 or QAR9530

Return Air Temperature Sensor QAM2030.010 or QAR9530

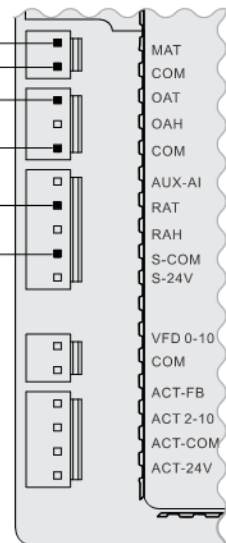

Relative Humidity Sensor Connection

- Outside Air Relative Humidity: Connect to the OAH and COM terminals of the device.
- Return Air Relative Humidity: Connect to the RAH and COM terminals of the device.

Outside Air Relative Humidity Sensor QFR9500

Return Air Relative Humidity Sensor QFR9500

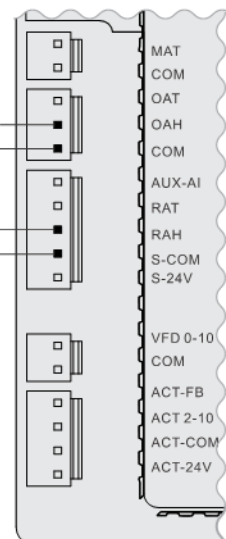

Combination Temperature/Humidity Sensor Connection

- Outside Combination Temperature/Humidity: Connect to the OAT, COM, and OAH terminals of the device.
- Return Combination Temperature/Humidity: Connect to the RAT, COM, and RAH terminals of the device.

Combo Temp + Humidity Sensor QFM2160U or QFR9530

Combo Temp + Humidity Sensor QFM2160U or QFR9530

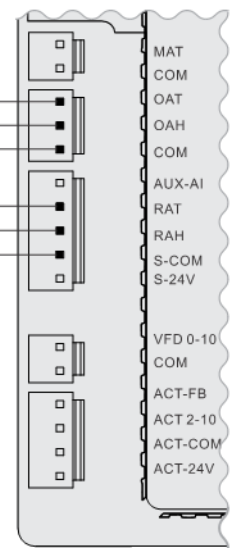

CO₂/Pressure Sensor Connection

- Connect to the AUX-AI and COM terminals of the device.

Air Quality Sensor or Pressure Sensor

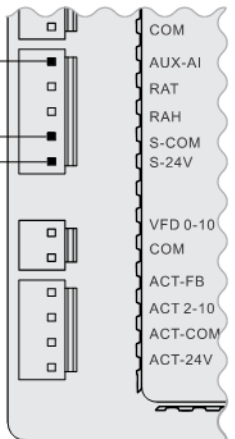

Variable Speed Supply Fan Connection

- Connect to the VFD 0-10 and COM terminals of the device.

Variable Speed Supply Fan Output

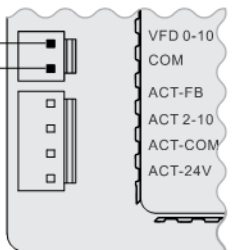

Damper Actuator Connection

- Connect to the ACT 2-10 and ACT-COM terminals of the device.

Damper Actuator: Power and 2-10 Vdc

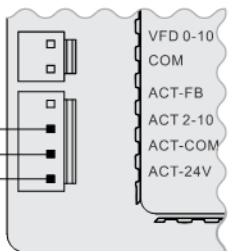

3.3.3 Wiring Application Examples

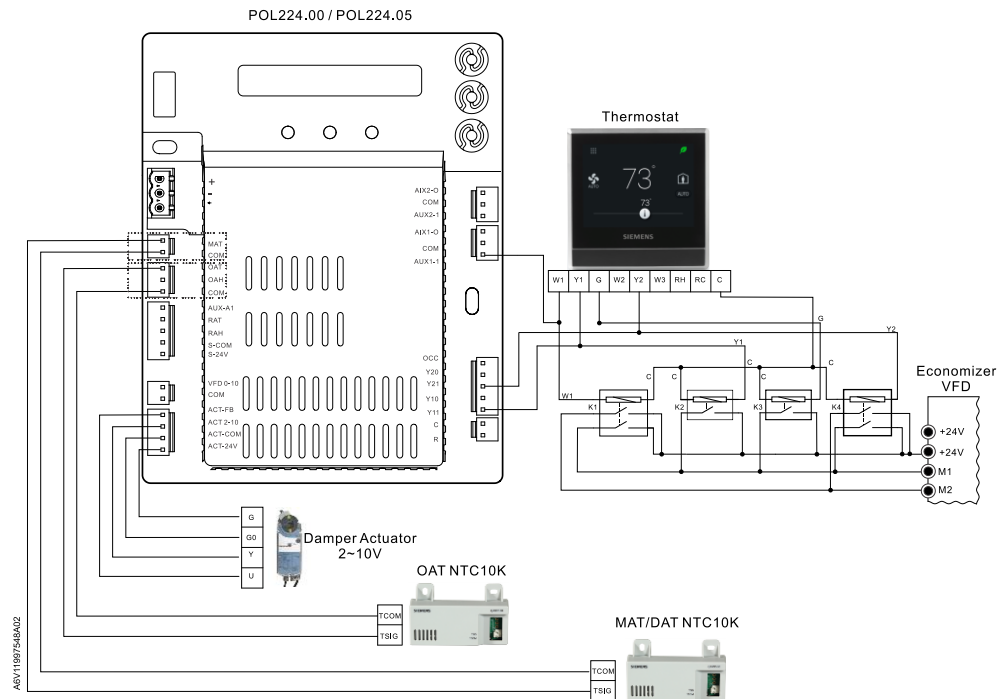

Fig. 1: Single Dry-Bulb Switchover + Thermostat + Damper Actuator + OAT & MAT Sensors

- K1 Relay 1, DPDT relay, dry contact, digital input 1 for fan high speed with W1 call
- K2 Relay 2, SPST relay, dry contact, digital input 2 for fan low speed with Y1 call
- K3 Relay 3, SPST relay, dry contact, digital input 3 for fan low speed with G call
- K4 Relay 4, DPST relay, dry contact, digital input 4 for fan high speed with Y2 call

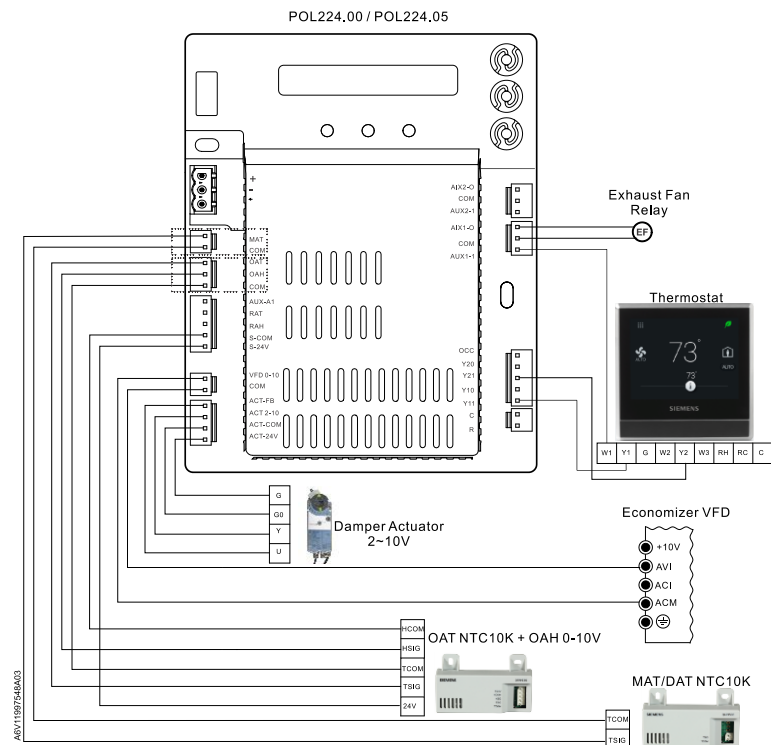
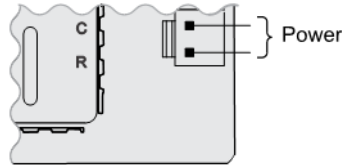

Fig. 2: Single Enthalpy Switchover + VFD + Thermostat + Exhaust Fan + Damper Actuator + OAT & MAT Sensors + OAH Sensor

4 Interface Overview

4.1 Powering the Economizer Controller

Connect a 24 Vac external power supply source to the following terminals to power the Economizer Controller.



4.2 LED Indication

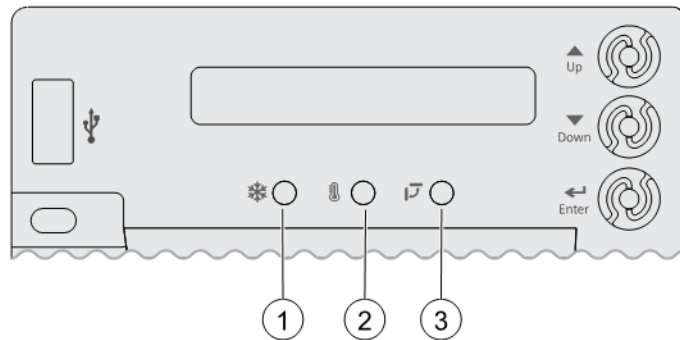

No.	Description
1	Free Cooling LED
2	Sensor LED
3	DAC LED

LED Indication

Status	Free Cooling LED	Sensor LED	DAC LED
Commissioning mode	Yellow Blinking	Yellow Blinking	Yellow Blinking
Power start-up	Yellow On	Yellow On	Yellow On
Free cooling is running	Green On	-	-
Free cooling is available but not running	Green Blinking	-	-
Not economizing when it should	Red Blinking	-	-
Economizing when it should not	Red On	-	-
Sensors working ok	-	Green On	-
Humidity sensor error	-	Yellow On	-
CO ₂ sensor error	-	LED Off	-

Status	Free Cooling LED	Sensor LED	DAC LED
Air temperature failure/fault	-	Red On	-
Excess outdoor air	-	Red Blinking	-
Damper working ok	-	-	Green On
Damper stalled	-	-	Red On
Damper slippage	-	-	Red Blinking
Actuator alarm is reported	-	-	Fast Red Blinking
Terminal ACT-FB is configured but no available feedback signal (under-range or over-range)	-	-	LED Off

NOTICE

If different faulty events occur at the same time, sensor/DAC LED lights up following the priority below: Red (Fast Blinking) -> Red (On, Steady) -> Red (Blinking) -> Yellow -> Off -> Green. For example, if there is a humidity sensor error and air temperature failure at the same time, the sensor LED turns red rather than yellow.

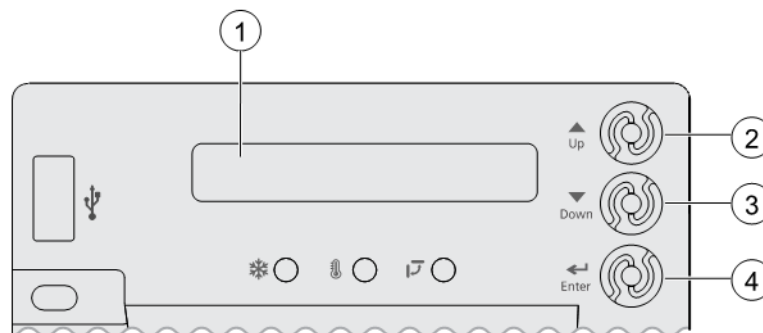

After the Economizer controller enters the running state, it may take one minute for peripheral devices to complete initialization. Before that, LED indication might be unstable.

4.3 User Interface

No.	Description
1	One-line LCD. After a period of inactivity, the controller displays the default HMI screen (free cooling status, '1FREECOOL YES' or '1FREECOOL NO')
2	Operation button (Up button) - Move to the previous value, step or category
3	Operation button (Down button)- Move to the next value, step or category

No.	Description
4	Operation button (Enter button): <ul style="list-style-type: none"> • Press to edit the current value or option. • Press to confirm a newly selected value or option. • Press Enter + Up to jump up one entire category. • Press Enter + Down to jump down one entire category.

4.4 Menu Structure

Menus are displayed in the Economizer Controller as per categories. There are eight first-level menus, each of which is represented by a number at the beginning of the line on the LCD. Pressing Enter + Up or Down can toggle between different first-level menus.

Submenus follow the numbered first-level menus closely. Pressing Up or Down can toggle between different submenus.

At the end of the line, the LCD displays the value of the current submenu (if any). If the value is editable, pressing Enter enters the Edit mode. The value is then highlighted for change. After making a change by pressing Up or Down, press Enter to confirm the change and exit the Edit mode.

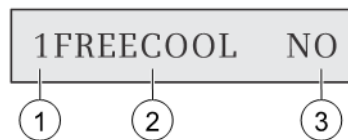

No.	Description
1	Number representing the first-level menu of Status Display . Different numbers represent different menus: <ul style="list-style-type: none"> • 1: Status Display • 2: Basic Settings • 3: Advanced Settings • 4: Alarms • 5: Enter Configuration State and Reset • 6: I/O Config • 7: Testing • 8: Enter Running State
2	Submenu*
3	Value of the current submenu*

* See Setup and Configuration [→ 32] for detailed submenus together with possible values or ranges.

5 Functions

5.1 Free Cooling Economizing

Free cooling uses unconditioned outside air to cool the space directly. The Economizer Controller enables or disables free cooling after it judges which control mode is active. It also uses hysteresis to ensure a smooth switchover.

Depending on the sensors that are used, there are four different control modes. In different control modes, the assessed conditions are different.

Control Mode	Used Sensors	Enable Free Cooling?
Control Mode 1 - Fixed Dry-bulb	OA (outside air) temperature sensor and MA (Mixed Air) temperature sensor	The outside-air dry-bulb temperature is compared with the set temperature shutoff setpoint (2TEMP OFF). If the outside-air dry-bulb temperature is below the temperature shutoff setpoint, the outside air is used to meet all or part of the cooling demand.
Control Mode 2 - Differential Dry-bulb (Dual Dry- Bulbs)	OA temperature sensor, RA (Return Air) temperature sensor and MA temperature sensor	The outside-air dry-bulb temperature is compared with the return-air dry-bulb temperature. If both OAT and RAT are higher than the temperature high limitation (2THL), free cooling is prohibited. If OAT or RAT is lower than the temperature high limitation and the outside-air dry-bulb temperature is lower than the return-air dry-bulb temperature, the outside air is used to meet all or part of the cooling demand.
Control Mode 3 - Combination Fixed Enthalpy and Fixed Dry-bulb Control	OA temperature and humidity sensor, and MA temperature sensor	The outside-air dry-bulb temperature and enthalpy are compared with the set temperature and enthalpy shutoff setpoints. If the outside-air enthalpy is lower than the set enthalpy shutoff setpoint (2ENTH OFF), and the outside-air dry bulb temperature is lower than the temperature shutoff setpoint, the outside air can be used for economizing.
Control Mode 4 - Combination of Differential Enthalpy and Fixed Dry-bulb	OA temperature and humidity sensor, RA temperature and humidity sensor, and MA temperature sensor	The outside-air dry-bulb temperature and enthalpy are compared with the temperature shutoff setpoint and return-air enthalpy. If both OA enthalpy and RA enthalpy are higher than the enthalpy high limitation (2EHL), free cooling is prohibited. If OA enthalpy or RA enthalpy is lower than the enthalpy high limitation, outside-air enthalpy is lower than the return-air enthalpy, and the outside-air dry-bulb temperature is lower than the set temperature shutoff setpoint, then outside air can be used for economizing.

Default hysteresis setting

Hysteresis setting (DB) between OAT and temperature shutoff setpoint defaults to 2 °F (non-changeable).

The temperature shutoff setpoint decides when to disable free cooling when the outside air temperature increases. However, once free cooling is disabled after the increased temperature is higher than the temperature shutoff setpoint, the hysteresis setting decides when to enable free cooling. When the temperature decreases and drops 2 °F (hysteresis setting) below the temperature shutoff setpoint, free cooling is enabled.

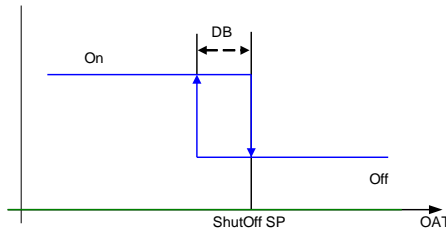

Damper modulation during free cooling

Once outside air is suitable for free cooling, the controller modulates the damper based on MAT (mixed air temperature, default) or OAT (outside air temperature).

If MAT is used when free cooling is enabled, MAT setpoint ('3MAT SET', configurable under Advanced Settings [→ 36]) is used for MAT modulating. When MAT falls below the anti-freeze setpoint (3FRZ PROT), the damper either fully closes or opens to the minimum position ('3FREEZE POS', configurable under Advanced Settings [→ 36]).

- If MAT is lower than MAT setpoint, the damper is modulated to maintain MAT setpoint, towards fully closes or opens to the minimum position based on occupancy status if MAT continues dropping.
- If MAT is in the range [MAT setpoint, (MAT setpoint + neutral zone band (1 °F by default, non-changeable))], the damper position remains no change.
- If MAT is higher than (MAT setpoint + neutral zone band), the damper opens towards fully open.
- If MAT is 10 °F higher than MAT setpoint, the damper fully opens to 100%.

If OAT is used when there is a cooling demand, the damper can be opened to different positions depending on different outside air temperatures:

- If outside air is higher than 50 °F but lower than the temperature shutoff setpoint, the damper is fully open.
- If outside air is higher than OAT lockout setpoint but lower than 50 °F, linear modulation is applied when only Cooling Stage 1 input (Y1I) is ON. Result of the following formula indicates the damper's open position:

$$((\text{OAT} - \text{OAT Lockout Setpoint}) / (50 - \text{OAT Lockout Setpoint})) * (80\% - \text{MIN POS}) + \text{MIN POS}$$

Note: After the Controller receives the second cooling demand, the damper fully opens regardless of the modulating logic. After fan delay (2FAN DLY) time runs out, mechanical cooling turns on.

5.2 Location-based Shutoff Setpoints

The Economizer Controller can get location-based temperature and enthalpy shutoff setpoints automatically if it is connected to the Climatix Mobile application. Once a WLAN stick is plugged, the Economizer Controller can establish network connection with the Climatix Mobile application. The temperature and enthalpy shutoff setpoints obtained via the phone or tablet's GPS functionality can then be synchronized to the Economizer Controller.

5.3 Cooling Stage Operation

The Economizer Controller accepts inputs for 1-, 2- and 3-stage cooling inputs, and reroutes to the RTU through the relay connection Y1, Y2 and AUX1/AUX2.

The operation of the cooling stages is determined by the availability of Free Cooling provided by the economizer operation mode. See Cooling Stage I/O Logic tables [→ 20].

Based on the use of Free Cooling, the operating modes are as follows:

- Y1 is Stage 1 Cooling Demand.
- Y2 is Stage 2 Cooling Demand.
- Y3 is Stage 3 Cooling Demand.
- Free Cooling is always the first cooling stage.
- Cooling Stage 1 call from the Commercial Thermostat (Y1) energizes the Y1 input to the Economizer Controller.
- Cooling Stage 2 call from the Commercial Thermostat (Y2) energizes the Y2 input to the Economizer Controller.
- Cooling Stage 3 call from the Commercial Thermostat energizes the AUX1/AUX2 input to the Economizer Controller.

Economizer condition met	Y1	Y2	Cooling Stage 1	Cooling Stage 2
No	On	On	On	On
No	On	Off	On	Off
No	Off	Off	Off	Off
Yes	On	On	On ¹⁾	On/Off ²⁾
Yes	On	Off	Off	Off
Yes	Off	Off	Off	Off

Table 1: 1- and 2-Stage Cooling I/O Logic

¹ If Y2-Input is called too, the controller increases fan speed to Speed High and starts fan delay (2FAN DLY) time. After the delay time runs out, the controller starts Y1-Output.

² If Y1O is **ON** for more than a set time (15 minutes by default, changeable via Parameter '3STG3 DLY)', Y2I cooling demand remains **ON**, and OAT is lower than MAT setpoint (3MAT SET), then Relay 2 is **OFF** to disable Cooling Stage 2. If the OAT is higher than the MAT setpoint, then Relay 2 energizes to allow Y2 pass-through to enable Cooling Stage 2.

Economizer condition met	Y1	Y2	Y3	Cooling Stage 1	Cooling Stage 2	Cooling Stage 3
No	On	On	On	On	On	On
No	On	On	Off	On	On	Off
No	On	Off	Off	On	Off	Off
No	Off	Off	Off	Off	Off	Off
Yes	On	On	On	On ¹⁾	On ²⁾	On/Off ⁴⁾
Yes	On	On	Off	On ¹⁾	On/Off ³⁾	Off
Yes	On	Off	Off	Off	Off	Off
Yes	Off	Off	Off	Off	Off	Off

Table 2: 1-, 2- and 3-Stage Cooling I/O Logic

- 1 If Y2-Input is called too, the controller increases fan speed to Speed High and starts fan delay (2FAN DLY) time. After the delay time runs out, the controller starts Y1-Output.
- 2 If Y3-Input is called too, the controller increases fan speed to Speed High and starts fan delay (2FAN DLY) time. After the delay time runs out, the controller starts Y2-Output.
- 3 If Y1O is **ON** for more than a set time (15 minutes by default, changeable via Parameter '3STG3 DLY'), Y2I cooling demand remains **ON**, and OAT is lower than MAT setpoint (3MAT SET), then Relay 2 is **OFF** to disable Cooling Stage 2. If the OAT is higher than the MAT setpoint, then Relay 2 energizes to allow Y2 pass-through to enable Cooling Stage 2.
- 4 If Y2O is **ON** for more than a set time (15 minutes by default, changeable via Parameter '3STG3 DLY'), Y3I cooling demand remains **ON**, and OAT is lower than MAT setpoint (3MAT SET), then Relay 3 is **OFF** to disable Cooling Stage 3. If the OAT is higher than the MAT setpoint, then Relay 3 energizes to allow Y3 pass-through to enable Cooling Stage 3.



The Economizer Controller tolerates thermostat wiring mismatch (e.g. Thermostat Y1 -> Economizer Y2-In, Thermostat Y2 -> Economizer Y1-In). It doesn't recognize if signal comes from Y1-In or Y2-In but calculates the number of received signals and decides the number of cooling/heating demands based on the received signal number. The handling logic is Stage = Y1I + Y2I + Y3I.

5.4 Multi-Speed Fan Support

The Economizer Controller supports connection to 2- and 3-speed fans. When the unit is equipped with a multi-speed fan, the damper responds to multiple fan speeds via multiple minimum positions (**MIN POS**) to keep minimum airflow.



A multi-speed fan is not controlled by the Economizer Controller but an external logic board.

Y1	Y2	Spd L ¹⁾	Spd H ²⁾	PosL ³⁾	PosH ⁴⁾
X	-	X	-	X	-
X	X	-	X	-	X

Table 3: Damper MIN POS for 2-Speed Fan (Cooling, No W1 or O/B)

Y1	Y2	W1 (Heating)	OB = B (Heating)	Spd L ¹⁾	Spd H ²⁾	PosL ³⁾	PosH ⁴⁾
X	-	-	X	X	-	-	X
X	X	-	X	-	X	-	X
-	-	X	-	-	X	-	X

Table 4: Damper MIN POS for 2-Speed Fan (Heating, With W1 or O/B)

- | | |
|----------------------------|--------------------------------------------|
| 1 Spd L = Low Speed (Fan) | 3 PosL = Damper MIN POS for Low-Speed Fan |
| 2 Spd H = High Speed (Fan) | 4 PosH = Damper MIN POS for High-Speed Fan |

Y1	Y2	Y3	Spd L ¹⁾	Spd M ²⁾	Spd H ³⁾	PosL ⁴⁾	PosM ⁵⁾	PosH ⁶⁾
X	-	-	X	-	-	X	-	-
X	X	-	-	X	-	-	X	-
X	X	X	-	-	X	-	-	X

Table 5: Damper MIN POS for 3-Speed Fan (Cooling, No W1 or O/B)

Y1	Y2	Y3	W1 (Heating)	OB = B (Heating)	Spd L ¹⁾	Spd M ²⁾	Spd H ³⁾	PosL ⁴⁾	PosM ⁵⁾	PosH ⁶⁾
X	-	-	-	X	X	-	-	-	-	X
X	X	-	-	X	-	X	-	-	-	X
X	X	X	-	X	-	-	X	-	-	X
-	-	-	X	-	-	-	X	-	-	X

Table 6: Damper MIN POS for 3-Speed Fan (Heating, With W1 or O/B)

- | | |
|------------------------------|----------------------------------------------|
| 1 Spd L = Low Speed (Fan) | 4 PosL = Damper MIN POS for Low-Speed Fan |
| 2 Spd M = Medium Speed (Fan) | 5 PosM = Damper MIN POS for Medium-Speed Fan |
| 3 Spd H = High Speed (Fan) | 6 PosH = Damper MIN POS for High-Speed Fan |



If a single-speed fan connects to the Controller, the fan speed is Spd H. The damper position is PosH.

	1-stage Cooling ²⁾	2-stage Cooling ²⁾	3-stage Cooling ²⁾
1-speed Fan¹⁾	Spd H ³⁾ (regardless of cooling demand, OCC=Yes)	Spd H ³⁾ (regardless of cooling demand, OCC=Yes)	Spd H ³⁾ (regardless of cooling demand, OCC=Yes)
2-speed Fan¹⁾	Spd L ⁴⁾ (0 or 1 cooling demand) Spd H ³⁾ (2 cooling demands)	Spd L ⁴⁾ (0 or 1 cooling demand) Spd H ³⁾ (2 cooling demands)	Spd L ⁴⁾ (0 or 1 cooling demand) Spd H ³⁾ (2 or 3 cooling demands)
3-speed Fan¹⁾	Spd L ⁴⁾ (0 or 1 cooling demand) Spd H ³⁾ (2 cooling demands)	Spd L ⁴⁾ (0 or 1 cooling demand) Spd H ³⁾ (2 cooling demands)	Spd L ⁴⁾ (0 or 1 cooling demand) Spd M ⁵⁾ (2 cooling demands) Spd H ³⁾ (3 cooling demands)

Table 7: Different Fan Speeds with Different Configured Outputs

- | | |
|----------------------------------|------------------------------|
| 1 Configured by '6FAN'. | 4 Spd L = Low Speed (Fan) |
| 2 Configured by Y10, Y20 or Y30. | 5 Spd M = Medium Speed (Fan) |
| 3 Spd H = High Speed (Fan) | |



If a variable-speed fan is configured, the fan speed control logic is the same with 3-speed fan.

	1-stage Cooling ²⁾	2-stage Cooling ²⁾	3-stage Cooling ²⁾
1-speed Fan¹⁾	2VENTMIN H (regardless of cooling demand, OCC=Yes)	2VENTMIN H (regardless of cooling demand, OCC=Yes)	2VENTMIN H (regardless of cooling demand, OCC=Yes)
2-speed Fan¹⁾	2VENTMIN H (regardless of cooling demand, OCC=Yes)	2VENTMIN L (0 or 1 cooling demand) 2VENTMIN H (2 cooling demands)	2VENTMIN L (0 or 1 cooling demand) 2VENTMIN H (2 or 3 cooling demands)
3-speed Fan¹⁾	2VENTMIN H (regardless of cooling demand, OCC=Yes)	2VENTMIN L (0 or 1 cooling demand) 2VENTMIN H (2 cooling demands)	2VENTMIN L (0 or 1 cooling demand) 2VENTMIN M (2 cooling demands) 2VENTMIN H (3 cooling demands)

Table 10: Different Damper Position Setting with Different Configured Outputs (DCV is Disabled, CO₂ sensor is connected)

1 Configured by '6FAN'.

2 Configured by Y10, Y20 or Y30.

5.5 Variable-Speed Fan Support

Once a variable-speed fan is configured with the Economizer Controller via terminal VFD 0-10 and the Fan Configuration in Climatix Mobile or '6FAN' in the inbuilt menu is configured as 'VFD FAN', the controller can control the fan speed following the logic below:

OCC	Y1	Y2	Y3	6FAN	VFD Speed	Spd L ¹⁾	Spd M ²⁾	Spd H ³⁾	Pos L ⁴⁾	Pos M ⁵⁾	Pos H ⁶⁾	DO ⁷⁾
Yes	x	-	-	VFD FAN	60%	x	-	-	x	-	-	On
Yes	x	x	-	VFD FAN	80%	-	x	-	-	x	-	On
Yes	x	x	x	VFD FAN	100%	-	-	x	-	-	x	On
Yes	-	-	-	VFD FAN	60%	x	-	-	x	-	-	On
No	x	-	-	VFD FAN	60%	x	-	-	-	-	-	On
No	x	x	-	VFD FAN	80%	-	x	-	-	-	-	On
No	x	x	x	VFD FAN	100%	-	-	x	-	-	-	On
No	-	-	-	VFD FAN	60% ⁸⁾	x	-	-	-	-	-	Off

Table 11: Variable-Speed Fan Control Logic During 3-Stage Cooling

OCC	Y1	Y2	Y3	W1 (Heating)	O/B = B (Heating)	6FAN	VFD Speed	Spd L ¹⁾	Spd M ²⁾	Spd H ³⁾	Pos L ⁴⁾	Pos M ⁵⁾	Pos H ⁶⁾	DO ⁷⁾
Yes	x	-	-	-	x	VFD FAN	60%	x	-	-	-	-	x	On
Yes	x	x	-	-	x	VFD FAN	80%	-	x	-	-	-	x	On
Yes	x	x	x	-	x	VFD FAN	100%	-	-	x	-	-	x	On
Yes	-	-	-	x	-	VFD FAN	100%	x	-	-	-	-	x	On
No	x	-	-	-	x	VFD FAN	60%	x	-	-	-	-	-	On
No	x	x	-	-	x	VFD FAN	80%	-	x	-	-	-	-	On

OCC	Y1	Y2	Y3	W1 (Heating)	O/B = B (Heating)	6FAN	VFD Speed	Spd L ¹⁾	Spd M ²⁾	Spd H ³⁾	Pos L ⁴⁾	Pos M ⁵⁾	Pos H ⁶⁾	DO ⁷⁾
No	x	x	x	-	x	VFD FAN	100%	-	-	x	-	-	-	On
No	-	-	-	x	-	VFD FAN	100%	x	-	-	-	-	-	On

Table 12: Variable-Speed Fan Control Logic During 3-Stage Heating

OCC	Y1	Y2	6FAN	VFD Speed	Spd L ¹⁾	Spd M ²⁾	Spd H ³⁾	Pos L ⁴⁾	Pos M ⁵⁾	Pos H ⁶⁾	DO ⁷⁾
Yes	x	-	VFD FAN	60%	x	-	-	x	-	-	On
Yes	x	x	VFD FAN	100%	-	x	-	-	-	x	On
Yes	-	-	VFD FAN	60%	x	-	-	x	-	-	On
No	x	-	VFD FAN	60%	x	-	-	-	-	-	On
No	x	x	VFD FAN	100%	-	x	-	-	-	-	On
No	-	-	VFD FAN	60% ⁸⁾	x	-	-	-	-	-	Off

Table 13: Variable-Speed Fan Control Logic During 2-Stage Cooling

OCC	Y1	Y2	W1 (Heating)	O/B = B (Heating)	6FAN	VFD Speed	Spd L ¹⁾	Spd M ²⁾	Spd H ³⁾	Pos L ⁴⁾	Pos M ⁵⁾	Pos H ⁶⁾	DO ⁷⁾
Yes	x	-	-	x	VFD FAN	60%	x	-	-	-	-	x	On
Yes	x	x	-	x	VFD FAN	100%	-	x	-	-	-	x	On
Yes	-	-	x	-	VFD FAN	100%	x	-	-	-	-	x	On
No	x	-	-	x	VFD FAN	60%	x	-	-	-	-	-	On
No	x	x	-	x	VFD FAN	100%	-	x	-	-	-	-	On
No	-	-	x	-	VFD FAN	100%	x	-	-	-	-	-	On

Table 14: Variable-Speed Fan Control Logic During 2-Stage Heating

- 1 Spd L = Low Speed (Fan)
- 2 Spd M = Medium Speed (Fan)
- 3 Spd H = High Speed (Fan)
- 4 Pos L = Damper MIN POS for Low-Speed Fan
- 5 Pos M = Damper MIN POS for Medium-Speed Fan
- 6 Pos H = Damper MIN POS for High-Speed Fan
- 7 Optional. Meaningful only if '6AUX1-O' or '6AUX2-O' is configured as 'SUP FAN'.
- 8 Adjustable later on if there is any customer request.



See I/O Configuration [→ 38] for configurations of '6FAN', '6AUX1-O' and '6AUX2-O'.



Fan speed in percentage for Spd L, Spd M and Spd H is only configurable in the Climatix Mobile app.

5.6 Cooling Delay via Increasing Fan Speed

If there is cooling demand while outside air is suitable for economizing, the Economizer Controller tries to increase fan speed to maximize the use of outside air first. If the cooling demand is not reached within a set time, mechanical cooling will be enabled.

Typical Field Application

Prerequisites:

- Outside air is suitable for economizing and free cooling is ON.
 - Fan connected to the controller supports multiple speeds. Cooling delay function doesn't work if only a one-speed fan is connected to the controller.
1. If it is a 2-speed fan and there are two cooling demand inputs/outputs, Y1-Input is called, the controller sets fan speed to Speed Low. Damper is fully open (100%).
 - If Y2-Input is called too, the controller increases fan speed to Speed High and starts fan delay (2FAN DLY) time. After the delay time runs out, the controller starts Y1-Output.
 - If the cooling demand is not reached after Y1-Output is ON within '3STG3 DLY' time and OAT is higher than MAT setpoint (3MAT SET), the controller starts Y2-Output.
 2. If it is a 3-speed fan, Y1-Input is called, the controller sets fan speed to Speed Low. Damper is fully open (100%).
 - If Y2-Input is called too, the controller increases fan speed to Speed Medium and starts '2FAN DLY' time. After the delay time runs out, the controller starts Y1-Output.
 - If Y3-Input is called too, the controller increases fan speed to Speed High and starts '2FAN DLY' time. After the delay time runs out, the controller starts Y2-Output.
 - If the cooling demand is not reached after Y2-Output is ON within '3STG3 DLY' time and OAT is higher than MAT setpoint, the controller starts Y3-Output.
 3. If a variable-speed fan is configured, cooling delay functions the same with 3-speed fan.

NOTICE



See more information about '2FAN DLY' and '3STG3 DLY' in Setup and Configuration [→ 32]. The default time is 5 and 15 minutes respectively.

5.7 Demand Control Ventilation (DCV)

The controller modulates the outside air damper based on the CO₂ level through the ppm value selected between the range of 500 and 2000 ppm. The measured CO₂ concentration value is compared with the set DCV setpoint. If the measured CO₂ concentration value is below the DCV setpoint, keep the damper to the minimum position. Otherwise, enable DCV.

Once DCV is enabled, the DCV PID starts to run to control the indoor CO₂ concentration value towards the DCV setpoint. The damper opens to the maximum position.



DCV is disabled if the controller receives no occupancy signal.

5.8 Free Cooling Shutdown

If a shutdown signal is configured in Climatix Mobile or '6AUX1-I'/'6AUX2-I' under the menu of I/O Configuration on the inbuilt display, free cooling function is shut down when the signal is enabled. Meanwhile, alarm '4RTU SHUTDOWN' is generated and displayed on the HMI.

During free cooling shutdown, compressor can open normally by-passing the free cooling function. The damper position depends on the parameter setting of '3SD ACT POS'. It is not affected by cooling/heating demand or occupancy status.

5.9 Anti-Freeze Protection

The Economizer Controller initiates the anti-freeze protection if MAT or OAT temperature falls below the anti-freeze setpoint.

If MAT and OAT sensors are connected to the Controller, both can trigger the anti-freeze protection independently. If the MAT sensor fails, MAT is substituted by OAT to continue the anti-freeze assessment. If OAT fails too, the controller either fully closes the damper or opens it to the minimum position based on occupancy status.

Once anti-freeze protection is enabled, alarm '4FREEZE ALARM' is generated and displayed on the HMI. Only if MAT and OAT temperatures increase to be 3 °F above the anti-freeze setpoint (3FRZ PROT) and OAT lockout setpoint (3OAT LOCK) respectively for one minute can the alarm be gone and the controller exit from the anti-freeze protection mode.

5.9.1 MAT-based Anti-Freeze Protection

MAT-based anti-freeze protection is enabled when MAT temperature falls below the anti-freeze setpoint (3FRZ PROT). **Note:** MAT temperature may be obtained by an MAT, LAT (default) or automatically. The anti-freeze protection logic is the same no matter how the temperature is obtained.

If unit type is conventional unit and cooling/heating conventional operation mode is enabled:

- The compressor is closed.
- The damper either fully closes or opens to the minimum position (configurable using Parameter '3FREEZE POS' under Advanced Settings [→ 36]) regardless of occupancy status. If the damper is set to open to the minimum position, the actual opened position depends on CO₂ sensor configuration:
 - On the call of cooling when no CO₂ sensor is configured, the actual minimum position is obtained from 2FAN L ACT. If a CO₂ sensor is configured, it is from 2VENTMIN L.
 - On the call of heating when no CO₂ sensor is configured, the actual minimum position is obtained from 2FAN H ACT. If a CO₂ sensor is configured, it is from 2VENTMIN H.

If unit type is heat pump and heat pump operation mode is enabled:

- The compressor is closed when there is cooling demand. On the call of heating, the controller opens the compressor.
- The damper behaves the same as the conventional operation mode. See the above for details.

NOTICE



DCV PID function doesn't work during MAT-based anti-freeze protection.

5.9.2 OAT-based Anti-Freeze Protection

OAT-based anti-freeze protection is enabled when OAT temperature falls below the OAT lockout setpoint (3OAT LOCK).

If unit type is conventional unit and cooling/heating conventional operation mode is enabled:

- The compressor is closed.
- The damper either fully closes or opens to the minimum position depending on occupancy status:
 - If the space is unoccupied, the damper fully closes.
 - If the space is occupied, the damper opens to the minimum position.
- If the space is detected as occupied, the actual opened position of the damper depends on CO₂ sensor configuration:
 - On the call of cooling when no CO₂ sensor is configured, the actual minimum position is obtained from 2FAN L ACT. If a CO₂ sensor is configured and the measured CO₂ concentration value is below the DCV setpoint (2DCV), it is from 2VENTMIN L. If the measured CO₂ concentration value is above the DCV setpoint, it is from 2VENTMAX L.
 - On the call of heating when no CO₂ sensor is configured, the actual minimum position is obtained from 2FAN H ACT. If a CO₂ sensor is configured and the measured CO₂ concentration value is below the DCV setpoint, it is from 2VENTMIN H. If the measured CO₂ concentration value is above the DCV setpoint, it is from 2VENTMAX H.

If unit type is heat pump and heat pump operation mode is enabled:

- The compressor is closed when there is cooling demand. On the call of heating, the controller opens the compressor.
- The damper behaves the same as the conventional operation mode. See the above for details.

NOTICE



DCV PID function works during OAT-based anti-freeze protection.

5.10 Exhaust Fan Operation

Up to two exhaust fans can be connected to the Economizer Controller.

If Exhaust Fan 1 is connected and configured, Exhaust Fan 1 parameter group (L, M and H) is available depending on fan configuration.

If Exhaust Fan 2 is connected and configured, Exhaust Fan 2 parameter group (L, M and H) is available depending on fan configuration.

The controller energizes Exhaust Fan Relay 1 and Exhaust Fan Relay 2 if the damper position reaches Exhaust Fan 1 parameter setting and Exhaust Fan Relay 2 parameter setting respectively. The selection of L, M or H matches the current fan speed (1FAN SPD LV).

Note that if terminal ACT-FB is configured, the damper position is the damper feedback position. If feedback signal is unavailable, it is the simulated position.

	1-stage Cooling ²⁾	2-stage Cooling ²⁾	3-stage Cooling ²⁾
1-speed Fan ¹⁾	EX H ³⁾ (regardless of cooling demand)	EX H ³⁾ (regardless of cooling demand)	EX H ³⁾ (regardless of cooling demand)
2-speed Fan ¹⁾	EX L ⁴⁾ (0 or 1 cooling demand) EX H ³⁾ (2 cooling demands)	EX L ⁴⁾ (0 or 1 cooling demand) EX H ³⁾ (2 cooling demands)	EX L ⁴⁾ (0 or 1 cooling demand) EX H ³⁾ (2 or 3 cooling demands)

	1-stage Cooling ²⁾	2-stage Cooling ²⁾	3-stage Cooling ²⁾
3-speed Fan¹⁾	EX L ⁴⁾ (0 or 1 cooling demand) EX H ³⁾ (2 cooling demands)	EX L ⁴⁾ (0 or 1 cooling demand) EX H ³⁾ (2 cooling demands)	EX L ⁴⁾ (0 or 1 cooling demand) EX M ⁵⁾ (2 cooling demands) EX H ³⁾ (3 cooling demands)

Table 15: Different Exhaust Fan Setpoints with Different Configured Outputs

- 1 Configured by '6FAN'.
- 2 Configured by Y1O, Y2O or Y3O.
- 3 EX H = Exhaust Fan 1/2 high-speed parameter setting
- 4 EX L = Exhaust Fan 1/2 low-speed parameter setting
- 5 EX M = Exhaust Fan 1/2 medium-speed parameter setting

5.11 Occupancy Input

The Economizer Controller can receive an occupancy signal from the connected thermostat or work under Occupied mode all the time. This is configurable in the Thermostat setup from Climatix Mobile or under the menu of I/O Configuration on the inbuilt display. See I/O Configuration [→ 38] for more information.



On the call of cooling when the controller is configured to receive signal from the thermostat but the thermostat is working under the Unoccupied mode, the damper is fully closed if free cooling is disabled or if there is no heating/cooling demand. If outside air is suitable for economizing and there is cooling demand, the damper can be opened normally. If the thermostat is working under the Occupied mode, the damper at least opens to the minimum position unless MAT-based anti-protection is enabled.

5.12 Pre-Occupancy Purge

The Pre-Occupancy purge demand comes from the configuration of the Auxiliary features in Climatix Mobile or '6AUX1-I'/'6AUX2-I' under the menu of I/O Configuration on the inbuilt display.

During pre-occupancy purge on the call of heating or when there is no cooling/heating demand, the damper position is MIN POS.

During pre-occupancy purge on the call of cooling, the damper position is MIN POS if outside air is not suitable for economizing. If outside air is suitable for economizing, the damper is fully open.

5.13 Airflow Commissioning

Airflow measurement station (differential pressure signal) can connect to the controller temporarily to run airflow commissioning to calculate, calibrate, and store four fan speed characteristic curves automatically at damper positions 40%, 60%, 80% and 100%. The controller places the damper to a proper position to meet minimum or any other airflow requests in cfm. You can enable this function only from the mobile app if the related function is available in your current mobile app version.

5.14 Dehumidification

The dehumidification function is available if fan control mode is VFD, and room temperature and humidity sensors are installed and connected to the controller. You can only enable this function via the Climatix mobile app if it is available in your current mobile app version.

If room dew point is greater than 62.2 °F (16.8 °C) and mechanical cooling is running, fan speed is reduced by 20% for efficient dehumidification. If room humidity level is 60.2 °F (15.7 °C) or lower, the controller stops fan speed setback. The fan speed returns to normal value.

5.15 Energy Recovery Ventilation (ERV)

The Controller can energize ERV to enable energy recovery when there is a difference between outside and inside air temperatures. Following is a list of prerequisites to energizing the ERV function:

- Auxiliary Features in Climatix Mobile or '6AUX1-O' or '6AUX2-O' in the inbuilt menu is configured as 'ERV'.
- The space is occupied.
- OAT is higher than the temperature shutoff setpoint (2TEMP OFF) when there is a cooling demand, or lower than ERV outside air temperature setpoint (2ERV SET) when there is a heating demand.
- The damper position is MIN POS.

5.16 Fault Detection and Diagnostics

The Economizer Controller can detect and diagnose free cooling faults, sensor operation faults and damper modulating faults. It can also report anti-freeze and shutdown notifications and actuator errors. Following is a list of all detectable or reportable information:

- Sensor disconnected or has no signal
- Sensor short or high signal (under range or over range)
- Not economizing
- Unexpected economizing
- Excess outdoor air
- Damper not modulating
- Input power monitor & brownout. After detecting brownout, the Economizer Controller enters the brownout protection mode and disables all of the relay outputs.
- Anti-freeze notifications
- Shutdown notifications
- Actuator errors
- Too low or too high leaving air temperature
- Damper actuator cycle count. Parameter '1ACT CNT' indicates number of times actuator has cycled. It is resettable via HMI item '8ACT CNT RESET'.



The first six faults are detectable via LEDs or alarm reports on the LCD. See LED Indication [→ 15] and Alarms [→ 37] for fault indications. These faults can also be displayed in the Operating section of the Climatix Mobile app.

5.17 Firmware Update

NOTICE



Back up configurations before firmware update. All the previous configuration data are erased after firmware update.

The Economizer supports firmware update via USB interface. If an update file (bin file) is available on [Siemens technical support website](#), do the following:

1. Download and rename the bin file to **ECO_FW.bin**, and then copy it to the root directory of a USB flash disk.
2. Power off the Economizer and then plug the USB flash disk to the USB port.
3. While pressing and holding down the Enter and Down buttons at the same time, power on the Economizer.
 - ⇒ The DAC LED starts to blink yellow. The firmware then starts to update. Release the buttons and wait for a short time.
 - ⇒ If the update is complete, all the three LEDs blink red regularly (in configuration state) or display real statuses (in running state).



If the controller enters the configuration state for the convenience of I/O configurations, you can manually switch to the running state after finishing configurations. To do so, press Enter + Up at the same time, and then press Enter to confirm the switch after '8RUN STATE' appears on the LCD.

6 Setup and Configuration



Before setup and configuration, it is recommended to obtain some location-based values such as shutoff points or utilize the location services in the Climatix mobile application.

Set up and configure the Economizer Controller before putting it into usage. This can be accomplished by using the Climatix Mobile app or the inbuilt display. After sensor, compressor, thermostat or actuator is connected to the Economizer Controller, values/statuses are displayed in the Operating section of the Climatix Mobile application and on the LCD. You can manually change basic and advanced settings, configure I/Os and test the damper operation and any configured outputs by modifying the corresponding parameter values in the local device or Climatix mobile application. Following chapters describe a complete list of all parameters that you can find on the LCD display. Refer to it during your setup and configuration process. Note that parameters and display menus may display differently/dynamically if different applications are configured.



Not all operations are available on the local POL224.00. For example, you can only obtain shutoff setpoints and perform CFM commissioning via the Climatix mobile application. Setup and configuration on the local device are only recommended if operations from the Climatix mobile application are unavailable. Check the Climatix mobile application for all operations that can be performed from the mobile application end.



By connecting the RS485 port to a PC, all parameters are also readable or writable from PC tools such as Modbus Poll.exe via Modbus and Yabe.exe via MSTP (Bps 38400 (default), Bps 9600, Bps 19200, Bps 115200). Note that an external End of Line (EOL) element is required to achieve Baud Rate 115200 at a maximum cable length of 4000ft (1.2km).

6.1 Status Display

Parameter	Description	Value
1FREECOOL	Indicates if the system can use outdoor air for free cooling.	YES
1ECON ENAB	Indicates if outdoor air is being used for the 1st stage of cooling.	NO
1OCCUPIED	Indicates if the space is occupied. If you choose 'ALWAYS' for '6OCC ' when configuring I/Os, the parameter value is 'YES'; if you keep the default selection 'T-STAT' for '6OCC ' and the controller receives 24V signal from OCC input, the value is 'YES'. Otherwise, the value is 'NO'.	
1Y1-IN	Y1-In call from thermostat for Cooling Stage 1	ON
1Y1-OUT	Y1-Out signal to compressor for Cooling Stage 1	OFF
1Y2-IN	Y2-In call from thermostat for Cooling Stage 2	
1Y2-OUT	Y2-Out signal to compressor for Cooling Stage 2 Dynamic item. Appears only if Y2-Out terminal is configured.	
1AUX1-I	Aux1-In signal Dynamic item. Appears only if Aux1-In terminal is configured.	

Parameter	Description	Value	
1AUX1-O	Aux1-Out signal Dynamic item. Appears only if Aux1-Out terminal is configured.		
1AUX2-I	Aux2-In signal Dynamic item. Appears only if Aux2-In terminal is configured.		
1AUX2-O	Aux2-Out signal Dynamic item. Appears only if Aux2-Out terminal is configured.		
1COMP STAGE	Indicates compressor current stage.	Off 1 2 3	
1HEAT ENAB	Indicates if heating is enabled.	YES	
1MIX AIR LOW	Indicates if the anti-freeze protection function is enabled for a mixed air temperature sensor. If the detected air temperature is lower than the anti-freeze protection setpoint (3FRZ PROT), the parameter value is 'YES'. Otherwise, it is 'NO'.	NO	
1MAT PRES	Indicates the present value of the mixed air temperature (MAT) sensor. Dynamic item. Appears only if 'MAT' or 'AUTO' is selected for '3DIF T LOC' under Advanced Settings [→ 36].	The corresponding detected value is displayed on the LCD.	
1LAT PRES	Indicates the present value of the leaving air temperature (LAT) sensor. Dynamic item. Appears only if 'LAT' or 'AUTO' is selected for '3DIF T LOC'.		
1OAT PRES	Indicates the present value of the outdoor air temperature (OAT) sensor. Dynamic item. Appears only if an OAT sensor is configured.		
1OAH PRES	Indicates the present value of the outdoor air relative humidity (OAH) sensor. Dynamic item. Appears only if an OAH sensor is configured.		
1RAT PRES	Indicates the present value of the return air temperature (RAT) sensor. Dynamic item. Appears only if an RAT sensor is configured.		
1RAH PRES	Indicates the present value of the return air relative humidity (RAH) sensor. Dynamic item. Appears only if an RAH sensor is configured.		
1CO2 PRES	Indicates the present value of the CO ₂ sensor. Dynamic item. Appears only if a CO ₂ sensor is configured.		
1DCV STATUS	Indicates the demand control ventilation (DCV) status. Dynamic item. Appears only if a CO ₂ sensor is configured. Displays ON if the measured CO ₂ concentration value is above the DCV setpoint and OFF if below the DCV setpoint.		ON OFF
1FAN SPD LV	Indicates the current fan speed status (low, medium or high). If a one-speed fan is connected and configured, this item is invisible. If a variable-speed fan is configured, the fan speed control logic is the same with 3-speed fan. Dynamic item. Appears only if '6FAN' is configured as '2SPEED', '3SPEED' or 'VFD FAN' under I/O Configuration [→ 38].		L M H

Parameter	Description	Value
1VFD SPD	Indicates the current VFD fan speed. Dynamic item. Appears only if '6FAN' is configured as 'VFD FAN'.	60% 80% 100%
1ACT OUT	Indicates current position of damper actuator in V.	The corresponding detected value is displayed on the LCD.
1ACT FB	Indicates feedback signal of damper actuator in V.	
1ACT POS	Indicates current position of damper actuator in % Open.	
1ACT CNT	Indicates number of times actuator has cycled (1 cycle = 180 degrees of movement in any direction). Resettable via HMI item '8ACT CNT RESET' under Enter Running State [→ 41].	
1EQUIP	Indicates the equipment type. If 'HP(O)' or 'HP(B)' is chosen for '6AUX1-I', the parameter value is 'HP(O)' or 'HP(B)' respectively. If neither is chosen, the value is 'CON RTU'.	HP(O) HP(B) CON RTU
1INS	Indicates the installation date of the Economizer Controller. If the installation date is incorrect, press Enter to change and confirm month, date and year.	-

6.2 Basic Settings

Note: Editable in 1TOP LEVEL. Do not have to use '5ENTER CONFIG?' to change values.

Parameter	Description	Range	Default
2TEMP OFF	Temperature shutoff setpoint. Automatically obtainable if a smartphone or tablet is connected to the network, a WLAN stick is plugged into the Economizer Controller and the mobile application is installed on the phone or tablet. You can also manually define this setpoint.	48...80 °F; increment by 1	63 °F
2ENTH OFF	Enthalpy shutoff setpoint. Automatically obtainable if a smartphone or tablet is connected to the network, a WLAN stick is plugged into the Economizer Controller and the mobile application is installed on the phone or tablet. You can also manually define this setpoint. Dynamic item. Appears only if an OAH sensor is configured.	22...30 Btu/lbm; increment by 1	28 Btu/lbm
2DCV	Demand control ventilation setpoint. Automatically obtainable if a smartphone or tablet is connected to the network, a WLAN stick is plugged into the Economizer Controller and the mobile application is installed on the phone or tablet. You can also manually define this setpoint. Dynamic item. Appears only if a CO ₂ sensor is configured.	500...2000PPM; increment by 100	1100PPM
2FAN L ACT	Damper minimum position when fan runs at a low speed. Dynamic item. Appears only if '6FAN' is configured as '2SPEED', '3SPEED' or 'VFD FAN' under I/O Configuration [→ 38].	2...10V; increment by 0.1	3.6V
2FAN M ACT	Damper minimum position when fan runs at a medium speed. Dynamic item. Appears only if '6FAN' is configured as '3SPEED' or 'VFD FAN'.	2...10V; increment by 0.1	3.2V

Parameter	Description	Range	Default
2FAN H ACT	Damper minimum position when fan runs at a high speed. Dynamic item. Appears only if '6FAN' is configured as '1SPEED', '2SPEED', '3SPEED' or 'VFD FAN'.	2...10V; increment by 0.1	2.8V
2VENTMAX L	DCV maximum position when fan runs at a low speed. Dynamic item. Appears only if a CO ₂ sensor is configured and '6FAN' is configured as '2SPEED', '3SPEED' or 'VFD FAN'.	2...10V; increment by 0.1	3.6V
2VENTMAX M	DCV maximum position when fan runs at a medium speed. Dynamic item. Appears only if a CO ₂ sensor is configured and '6FAN' is configured as '3SPEED' or 'VFD FAN'.	2...10V; increment by 0.1	3.2V
2VENTMAX H	DCV maximum position when fan runs at a high speed. Dynamic item. Appears only if a CO ₂ sensor is configured and '6FAN' is configured as '1SPEED', '2SPEED', '3SPEED' or 'VFD FAN'.	2...10V; increment by 0.1	2.8V
2VENTMIN L	DCV minimum position when fan runs at a low speed. Dynamic item. Appears only if a CO ₂ sensor is configured and '6FAN' is configured as '2SPEED', '3SPEED' or 'VFD FAN'.	2...10V; increment by 0.1	3.1V
2VENTMIN M	DCV minimum position when fan runs at a medium speed. Dynamic item. Appears only if a CO ₂ sensor is configured and '6FAN' is configured as '3SPEED' or 'VFD FAN'.	2...10V; increment by 0.1	2.7V
2VENTMIN H	DCV minimum position when fan runs at a high speed. Dynamic item. Appears only if a CO ₂ sensor is configured and '6FAN' is configured as '1SPEED', '2SPEED', '3SPEED' or 'VFD FAN'.	2...10V; increment by 0.1	2.3V
CFM COMM	Air Flow Chart. CFM commissioning can only be initiated from the mobile application. When CFM commissioning is in progress, the local device reads 'CFM COMM'.	-	-
2DEGREES	Temperature unit (°F or °C)	-	°F
2FAN	Fan CFM	100... 50,000CFM; increment by 100	5000CFM
2ERV SET	ERV outside air temperature setpoint. Dynamic item. Appears only if 'ERV' is selected for '6AUX1-O' or '6AUX2-O'.	0...50 °F; increment by 1	32 °F
2EX1 L	Exhaust Fan 1 low-speed parameter setting. Dynamic item. Appears only if: <ul style="list-style-type: none"> Exhaust Fan 1 is configured. '6FAN' is configured as '2SPEED', '3SPEED' or 'VFD FAN'. 	0...100%; increment by 1	65%
2EX1 M	Exhaust Fan 1 medium-speed parameter setting Dynamic item. Appears only if: <ul style="list-style-type: none"> Exhaust Fan 1 is configured. '6FAN' is configured as '3SPEED' or 'VFD FAN'. 	0...100%; increment by 1	60%

Parameter	Description	Range	Default
2EX1 H	Exhaust Fan 1 high-speed parameter setting Dynamic item. Appears only if: <ul style="list-style-type: none"> Exhaust Fan 1 is configured. '6FAN' is configured as '1SPEED', '2SPEED', '3SPEED' or 'VFD FAN'. 	0...100%; increment by 1	50%
2EX2 L	Exhaust Fan 2 low-speed parameter setting. Dynamic item. Appears only if: <ul style="list-style-type: none"> Exhaust Fan 2 is configured. '6FAN' is configured as '2SPEED', '3SPEED' or 'VFD FAN'. 	0...100%; increment by 1	80%
2EX2 M	Exhaust Fan 2 medium-speed parameter setting Dynamic item. Appears only if: <ul style="list-style-type: none"> Exhaust Fan 2 is configured. '6FAN' is configured as '3SPEED' or 'VFD FAN'. 	0...100%; increment by 1	78%
2EX2 H	Exhaust Fan 2 high-speed parameter setting Dynamic item. Appears only if: <ul style="list-style-type: none"> Exhaust Fan 2 is configured. '6FAN' is configured as '1SPEED', '2SPEED', '3SPEED' or 'VFD FAN'. 	0...100%; increment by 1	75%
2THL	Temperature high limitation Dynamic item. Appears only if an RAT sensor is configured.	80...100 °F; increment by 1	83 °F
2EHL	Enthalpy high limitation Dynamic item. Appears only if an RAH sensor is configured.	30...50 BTU/Lbm; increment by 1	33 BTU/Lbm
2FAN DLY	Cooling delay via increasing fan speed	0...30 min; increment by 1	5 min

6.3 Advanced Settings

Parameter	Description	Value/Range	Default
3FREEZE POS	Anti-freeze protection damper position (closed or minimum) when the Controller is under MAT-based anti-freeze protection.	CLO MIN	CLO
3STG3 DLY	Highest stage cooling delay time	0...240m; increment by 5	15m
3SD ACT POS	Damper position during shutdown (open or closed)	CLO OPN	CLO
3DIF T LOC	MAT sensor location: <ul style="list-style-type: none"> Choose 'MAT' if the sensor is installed before the DX (Direct Expansion) coil. Choose 'LAT' if the sensor is installed after the DX coil. Choose 'AUTO' to let the Economizer Controller automatically detect the location. 	MAT LAT AUTO	LAT

Parameter	Description	Value/Range	Default
3LAT LOW	Low limit of leaving air temperature (For 4LLA ALARM) Dynamic item. Appears only if 'LAT' or 'AUTO' is selected for '3DIF T LOC'.	35...65 °F; increment by 1	45 °F
3LAT HIGH	High limit of leaving air temperature (For 4HLA ALARM) Dynamic item. Appears only if 'LAT' or 'AUTO' is selected for '3DIF T LOC'.	70...158 °F; increment by 1	80 °F
3OAT CAL	OAT sensor calibration	-2.5...2.5 °F; increment by 0.5	0 °F
3RAT CAL	RAT sensor calibration Dynamic item. Appears only if an RAT sensor is configured.		
3OAH CAL	OAH sensor calibration Dynamic item. Appears only if an OAH sensor is configured.	-10...10%; increment by 0.5	0%
3RAH CAL	RAH sensor calibration Dynamic item. Appears only if an RAH sensor is configured.		
3MAT CAL	MAT or LAT sensor calibration	-2.5...2.5 °F; increment by 0.5	0 °F
3MAT SET	Setpoint of MAT or LAT sensor	38...70 °F; increment by 1	53 °F
3FRZ PROT	Anti-freeze protection setpoint of MAT sensor	35...55 °F; increment by 1	45 °F
3ACT TOLR	Actuator tolerance setpoint between output (in percentage) and feedback (in percentage).	0...15%; increment by 1	8%
3OAT LOCK	OAT lockout setpoint for anti-freeze protection	20...45 °F; increment by 1	32 °F

6.4 Alarms

Parameter	Description
NO ALARM	No alarm is activated.
4MAT SEN ALARM	MAT/LAT sensor has failed, gone out of range or become disconnected.
4CO2 SEN ALARM	CO ₂ sensor has failed, gone out of range or become disconnected.
4OAT SEN ALARM	OAT sensor has failed, gone out of range or become disconnected.
4OAH SEN ALARM	OAH sensor has failed, gone out of range or become disconnected.
4RAT SEN ALARM	RAT sensor has failed, gone out of range or become disconnected.
4RAH SEN ALARM	RAH sensor has failed, gone out of range or become disconnected.
4FREEZE ALARM	Anti-freeze notification when MAT/OAT sensor is below anti-freeze protection setpoint.

Parameter	Description
4RTU SHUTDOWN	Notification of Shutdown Active when 'SHUTDOWN' is chosen for '6AUX1-I' or '6AUX2-I'.
4ACTUATOR ALARM	Actuator output has failed, or the gap between the actuator output (in percentage) and feedback (in percentage) is bigger than the actuator tolerance setpoint (3ACT TOLR).
4ACT UNDER V	Voltage received by the actuator is below expected range (2-10 Vdc).
4ACT OVER V	Voltage received by the actuator is above expected range (2-10 Vdc).
4ACT STALLED	Damper actuator stopped before achieving commanded position.
4ACT SLIPPING	Damper actuator slips after reaching commanded position.
4NOT ECON	Not Economizing when it should
4ECON SHOULDNT	Economizing when it should not
4EXCESS OA	Excess outdoor air. Outside air intake is significantly higher than it should be
4LLA ALARM	Leaving air temperature is lower than the low limit (3LAT LOW).
4HLA ALARM	Leaving air temperature is higher than the high limit (3LAT HIGH).
4HEAT ALARM	Economizer heating error
4COOL ALARM	Economizer cooling error



All alarms are dynamic items. An alarm appears only if a related symptom mentioned above is detected.

An alarm activation triggers a general alarm, then the configured system alarm output (AUX1-O or AUX2-O) is activated. If there is no alarm, 'NO ALARM' is displayed on the HMI.

6.5 Enter Configuration State and Restart

Parameter	Description
5CONFIG STATE	Change to Configuration State. Press Enter to confirm the change.
5ENTER CONFIG?	Confirm the change to Configuration State.
5RESTART	Restart the Economizer Controller. Press Enter to confirm the restart.
5CONF RESTART?	Confirm the restart.

6.6 I/O Configuration

Parameter	Description	Value	Default
6OCC	Configures if occupancy status receives signal from the connected thermostat or is displayed as 'ALWAYS' in the Economizer Controller.	T-STAT ALWAYS	T-STAT

Parameter	Description	Value	Default
6AUX1-I	Auxiliary DI-1. Configurable as: <ul style="list-style-type: none"> None Cooling stage 3 (Y3) from thermostat Heat Conventional (W1) from thermostat Heat pump (reversing valve O) Heat pump (reversing valve B) Pre-occupancy signal from thermostat Shutdown signal from RTU 	NONE SHUTDWN PREOCC HP(B) HP(O) W1 Y3 IN	W1
6AUX2-I	Auxiliary DI-2. Configurable as: <ul style="list-style-type: none"> None Cooling stage 3 (Y3) from thermostat Heat stage 1 (W1) from thermostat Heat pump (reversing valve O) Heat pump (reversing valve B) Pre-occupancy signal from thermostat Shutdown signal from RTU <p>Note: Whichever is chosen for '6AUX1-I' doesn't appear in the list of '6AUX2-I'.</p>	NONE SHUTDWN PREOCC HP(B) HP(O) W1 Y3 IN	NONE
6OAT SIG	Configures signal type of OAT sensor.	NTC10K 0-10V	NTC10K
6RAT SIG	Configures signal type of RAT sensor.	NONE 0-10V NTC10K	NONE
6OAH SIG	Configures signal type of OAH sensor.	0-10V	NONE
6RAH SIG	Configures signal type of RAH sensor.	NONE 4-20mA	
6MAT SIG	Configures signal type of MAT or LAT sensor.	NTC10K 0-10V	NTC10K
6AUX-AI1	Auxiliary AI-1. Configurable as: <ul style="list-style-type: none"> CO₂ sensor Static pressure (temporarily for CFM commissioning) sensor None 	NONE PRESSURE CO2	NONE
6X-AI1 SIG	Configures CO ₂ sensor type. Dynamic item. Appears only if 'CO2' is selected for '6AUX-AI1'.	0-10V 2-10V 0-5V	0-10V
6CO2 Rng L	Configures the low limit of CO ₂ measuring range. Dynamic item. Appears only if 'CO2' is selected for '6AUX-AI1'.	0...500; increment by 10	0
6CO2 Rng H	Configures the high limit of CO ₂ measuring range. Dynamic item. Appears only if 'CO2' is selected for '6AUX-AI1'.	1000...3000; increment by 50	2000
6AUX-AI2	Choose 'ACT FB' if feedback signal is available from the connected damper actuator. Otherwise, choose 'NONE'.	ACT FB NONE	ACT FB
6AUX-AO	Choose 'VFD' if a VFD (Variable Frequency Drive) is connected to the Economizer. Otherwise, choose 'NONE'.	NONE VFD	NONE

Parameter	Description	Value	Default
6Y2O	Choose 'COOL 2' if Cooling Stage 2 is available (another compressor is connected to the Economizer). Otherwise, choose 'NONE'.	COOL 2 NONE	COOL 2
6AUX1-O	Auxiliary DO-1. Configurable as: <ul style="list-style-type: none"> None Cooling stage 3 output Exhaust fan (1 or 2) Variable speed supply fan Alarm output to thermostat (Title 24) ERV 	NONE ERV ALARM SUP FAN EXHAUST Y3O	EXHAUST
6AUX2-O	Auxiliary DO-2. Configurable as: <ul style="list-style-type: none"> None Cooling stage 3 output Exhaust fan (1 or 2) Variable speed supply fan Alarm output to thermostat (Title 24) ERV <p>Note: Of all but Exhaust Fan, whichever is chosen for '6AUX1-O' doesn't appear in the list of '6AUX2-O'.</p>	NONE ERV ALARM SUP FAN EXHAUST Y3O	ALARM
6FAN	Configures fan speeds of the variable speed supply fan.	1SPEED 2SPEED 3SPEED VFD FAN	2SPEED
6RS485	Switch between MSTP and Modbus slave.	MSTP MODBUSSLV	MSTP

6.7 Test

Parameter	Description
7DAMPER MIN POS	Press Enter to test if the Economizer Controller can drive damper to minimum position.
7DAMPER CLOSE	Press Enter to test if the Economizer Controller can drive damper to 100% Closed.
7DAMPER OPEN	Press Enter to test if the Economizer Controller can drive damper to 100% Open.
7DAMPER ALL	Press Enter to perform all the above tests and then drive damper to 100% Closed.
7DAMPER	Press Enter to test if the Economizer Controller can drive damper to the selected voltage.
7Y1O	Press Enter to test if the Economizer Controller can turn on or off the first stage of cooling (close or open relay Y1O).
7Y2O	Press Enter to test if the Economizer Controller can turn on or off the second stage of cooling (close or open relay Y2O).
7AUX1-O	Press Enter to test AUX1-O connection (close or open relay AUX1-O).
7AUX2-O	Press Enter to test AUX2-O connection (close or open relay AUX2-O).
7AUX AO	Press Enter to test if the Economizer Controller can set the AUX AO (VFD0-10) to the selected voltage.

6.8 Enter Running State

Parameter	Description
8RUN STATE	Change to Running State. Press Enter to confirm the change.
8ENTER RUN?	Confirm the change to Running State.
8FACTORY DEF	Perform factory resetting. Press Enter to confirm the reset.
8DEF CONFIRM?	Confirm the factory resetting.
8ACT CNT RESET	Damper count reset
8VER x.x.x	Firmware version information such as 0.1.10.

7 Sequence of Operation (Examples)

Thermostat			Economizer						
Control Mode		Occupied	OA Good to Economize ?	Y1I	Y2I	Y1O	Y2O	Damper Position	
Conventional	Cooling	Yes	NA	Off	Off	Off	Off Y2O	FAN L ACT	
			Yes	On	Off	Off	Off	Off	FAN L ACT to 100%
				On	On, <15 mins	On ¹⁾	Off	FAN H ACT to 100%	
				On	On, >15 mins	On ¹⁾	On/Off ²⁾	FAN H ACT to 100%	
			No	On	Off	On	Off	FAN L ACT	
	On	On		On	On	FAN H ACT			
	Heating	Yes	NA	Off	Off	Off	Off	FAN H ACT	
	Cooling	No	NA	Off	Off	Off	Off	Closed	
			Yes	On	Off	Off	Off	Off	Closed to 100%
				On	On, <15 mins	On ¹⁾	Off	Closed to 100%	
				On	On, >15 mins	On ¹⁾	On/Off ²⁾	Closed to 100%	
			No	On	Off	On	Off	Closed	
	On	On		On	On	Closed			
	Heating	No	NA	Off	Off	Off	Off	Closed	
	Heat Pump	Cooling	Yes	NA	Off	Off	Off	Off	FAN L ACT
Yes				On	Off	Off	Off	Off	FAN L ACT to 100%
				On	On, <15 mins	On ¹⁾	Off	FAN H ACT to 100%	
				On	On, >15 mins	On ¹⁾	On/Off ²⁾	FAN H ACT to 100%	
No				On	Off	On	Off	FAN L ACT	
		On	On	On	On	FAN H ACT			
Heating		Yes	NA	Off	Off	Off	Off	FAN L ACT	
				On	Off	On	Off	FAN H ACT	
				On	On	On	On	FAN H ACT	
Cooling		No	NA	Off	Off	Off	Off	Closed	
			Yes	On	Off	Off	Off	Off	Closed to 100%
				On	On, <15 mins	On ¹⁾	Off	Closed to 100%	
				On	On, >15 mins	On ¹⁾	On/Off ²⁾	Closed to 100%	
			No	On	Off	On	Off	Closed	
On		On		On	On	Closed			
Heating	No	NA	Off	Off	Off	Off	Closed		
			On	Off	On	Off	Closed		
			On	On	On	On	Closed		

Table 16: Fixed Dry-bulb No DCV (CO₂ Sensor) - 2-speed Fan

- 1 If Y2-Input is called too, the controller increases fan speed to Speed High and starts fan delay (2FAN DLY) time. After the delay time runs out, the controller starts Y1-Output.
- 2 If Y1O is **ON** for more than a set time (15 minutes by default, changeable via Parameter '3STG3 DLY'), Y2I cooling demand remains **ON**, and OAT is lower than MAT setpoint (3MAT SET), then Relay 2 is **OFF** to disable Cooling Stage 2. If the OAT is higher than the MAT setpoint, then Relay 2 energizes to allow Y2 pass-through to enable Cooling Stage 2.

Thermostat		Economizer								
Control Mode	Occupied	OA Good to Economize?	CO ₂	Y1I	Y2I	Y1O	Y2O	Damper Position	EF (1 or 2) ¹⁾	
Conventional	Cooling	No	NA	NA	Off	Off	Off	Off	Closed	Off
		Yes	NA	>SP ²⁾	Off	Off	Off	Off	VENT MIN L to VENT MAX L	On/Off ³⁾
				≤SP	Off	Off	Off	Off	VENT MIN L	Off
		No	Yes	NA	On	Off	Off	Off	Closed to Fully Open (100%)	On
					On	On	On ⁴⁾	On/Off ⁵⁾	Fully open (100%)	On
		Yes	Yes	>SP	On	Off	Off	Off	VENT MIN L to 100%	On
					On	On	On ⁴⁾	On/Off ⁵⁾	VENT MIN H to 100%	On
					On	Off	Off	Off	VENT MIN L or 100%	On
					On	On	On ⁴⁾	On/Off ⁵⁾	VENT MIN H or 100%	On
		No	No	NA	On	Off	On	Off	Closed	Off
					On	On	On	On		
		Yes	No	>SP	On	Off	On	Off	VENT MIN L to VENT MAX L	On/Off ³⁾
	On				On	On	On	VENT MIN H to VENT MAX H	On/Off ³⁾	
	On				Off	On	Off	VENT MIN L	Off	
	On				On	On	On	VENT MIN H	Off	
	Heating	No	NA	NA	Off	Off	Off	Off	Closed	Off
Yes		NA	≤SP	Off	Off	Off	Off	VENT MIN H	Off	
	>SP		Off	Off	Off	Off	VENT MIN H to VENT MAX H	On/Off ³⁾		
Heat Pump	Cooling	Yes	NA	>SP	Off	Off	Off	Off	VENT MIN L to VENT MAX L	On/Off ³⁾
				≤SP	Off	Off	Off	Off	VENT MIN L	Off
		Yes	Yes	>SP	On	Off	Off	Off	VENT MIN L to 100%	On
					On	On	On ⁴⁾	On/Off ⁵⁾	Fully open (100%)	On
					On	Off	Off	Off	VENT MIN L to 100%	On
					On	On	On ⁴⁾	On/Off ⁵⁾	Fully open (100%)	On
Yes	No	>SP	On	Off	On	Off	VENT MIN L to VENT MAX L	On/Off ³⁾		

Thermostat		Economizer								
Control Mode		Occupied	OA Good to Economize?	CO ₂	Y1I	Y2I	Y1O	Y2O	Damper Position	EF (1 or 2) ¹⁾
				>SP	On	On	On	On	VENT MIN H to VENT MAX H	On/Off ³⁾
				≤SP	On	Off	On	Off	VENT MIN L	Off
				≤SP	On	On	On	On	VENT MIN H	Off
	Heating	Yes	NA	>SP	Off	Off	Off	Off	VENT MIN L to VENT MAX L	On/Off ³⁾
				>SP	On	Off	On	Off	VENT MIN H to VENT MAX H	On/Off ³⁾
				>SP	On	On	On	On	VENT MIN H to VENT MAX H	On/Off ³⁾
				≤SP	Off	Off	Off	Off	VENT MIN L	Off
				≤SP	On	Off	On	Off	VENT MIN H	Off
				≤SP	On	On	On	On	VENT MIN H	Off
	Cooling	No	NA	NA	Off	Off	Off	Off	Closed	Off
			Yes	NA	On	Off	Off	Off	Closed to 100%	On
		No	No	NA	On	On	On ⁴⁾	On/Off ⁵⁾	100%	On
					On	Off	On	Off	Closed	Off
		No	No	NA	On	On	On	On	Closed	Off
					On	On	On	On	Closed	Off
	Heating	No	NA	NA	Off	Off	Off	Off	Closed	Off
					On	Off	On	Off	Closed	Off
					On	On	On	On	Closed	Off

Table 17: Fixed Dry-bulb With DCV (CO₂ Sensor) - 2-speed Fan

- 1 Exhaust Fan. One or two exhaust fans can be connected to the Economizer Controller.
- 2 Setpoint. Demand control ventilation setpoint.
- 3 The controller energizes Exhaust Fan Relay 1 and Exhaust Fan Relay 2 if the damper position reaches Exhaust Fan 1 parameter setting and Exhaust Fan Relay 2 parameter setting respectively.
- 4 If Y2-Input is called too, the controller increases fan speed to Speed High and starts fan delay (2FAN DLY) time. After the delay time runs out, the controller starts Y1-Output.
- 5 If Y1O is **ON** for less than a set time (15 minutes by default, changeable via Parameter '3STG3 DLY)', Relay 2 is **OFF**.
If Y1O is **ON** for more than a set time, Y2I cooling demand remains **ON**, and OAT is lower than MAT setpoint (3MAT SET), then Relay 2 is **OFF** to disable Cooling Stage 2. If the OAT is higher than the MAT setpoint, then Relay 2 energizes to allow Y2 pass-through to enable Cooling Stage 2.

8 Troubleshooting

Symptom	Reason	Solution
The Economizer Controller/ Mechanical Cooling is not operating	No input power	Use a multi-meter to check if there is 24 Vac +/- 25% (18 Vac - 30 Vac) at the POWER terminals. If there is no voltage or if the voltage is significantly low, check the transformer output voltage at the RTU. If 24 volts is not present at the transformer secondary side, check the primary line voltage to the transformer. If the line voltage is not present at the transformer primary side, check the primary power to the RTU, fuses, circuit breaker, and so on.
	Brownout	If voltage is below 17 Volts, the Economizer Controller may be in Brownout Protection mode. This mode disables all of the relay outputs. When the power is 19 Vac or higher, the Economizer Controller and RTU operate normally.
	Y1/Y2 signal is missing from the thermostat	Mechanical Cooling doesn't run until there is cooling demand (Y1/Y2 Active). Check the wiring from Y1I and Y2I terminals to the commercial thermostat. 24V should be present between Y1I /Y2I and Y1O/Y2O respectively.
	24 Vac~ and 24 Vac ⊥ are incorrectly wired	24 Vac power supply has polarity when all devices are powered by the same 24 Vac transformer; reversing polarity may cause a short circuit that can damage the system. Follow the transformer polarity mark, check the wiring of 24V~ (or G or 24V+) and ensure that they are tied to the same polar of 24 Vac power supply; while checking the wiring of ⊥ (or G0 or 24V- or COM) and ensure that they are all tied to another polar of 24 Vac power supply.
Free Cooling LED is solid RED	Sensor, damper or the whole working system may not work properly	Check sensor, damper or the whole working system following the detailed alarm information.
Free Cooling LED is blinking RED	Not economizing when it should	Check the whole Economizer working system such as sensor, damper and thermostat.
Sensor LED is solid RED	MAT/LAT sensor error	Check the MA sensor, it must be either a Type II NTC 10K or 0-10Vdc sensor.
	Outside Air (OA)/Return Air (RA) sensor error	Check the wiring and signal of OA sensor. If in Differential (DIFF) mode, check the RA sensor too. The following sensor signals are valid: <ul style="list-style-type: none"> • Type II NTC 10K or 0-10Vdc temperature • 0-10Vdc or 4-20 mA humidity
	Air temperature failure/fault	Check the air temperature sensor signal. The valid signal must be Type II NTC 10K or 0-10Vdc.
Sensor LED is blinking RED	Excess outdoor air	Check the whole Economizer working system such as sensor, damper and thermostat.
Sensor LED is yellow	Humidity sensor error	Check humidity sensor connection, sensor signal (under range or over range) and sensor signal type.
Sensor LED is OFF	CO ₂ sensor error	Check CO ₂ sensor connection, sensor signal (under range or over range) and sensor signal type.
DAC LED is blinking RED	Damper slippage	Check if the damper works properly.
DAC LED is blinking RED quickly	Actuator alarm is reported	Check if actuator output has failed, or the gap between the actuator output (in percentage) and feedback (in percentage) is bigger than the actuator tolerance setpoint (3ACT TOLR).

Symptom	Reason	Solution
DAC LED is OFF	Terminal ACT-FB is configured but no available feedback signal	Check if the feedback signal is under range or over range; check if ACT-FB is faulty or not.
The controller has no alarm, but the Free Cooling LED never turns on even though the OA seems to be suitable for Free Cooling	Shutoff SP setting error	The shutoff temperature and/or enthalpy setpoint is incorrectly set up. Consult an HVAC professional to set up the shutoff setpoint correctly.
	OA temp is too low	The OAT is too low; therefore, there is no cooling demand. This could possibly enable anti-freeze protection.
	OA temp is too high or too humid	In DIFF mode, even though OA temperature is lower than RA temperature, if both OA and RA temperatures exceed the high limit, Free Cooling turns off. In Differential Enthalpy control mode, even though OA enthalpy is lower than RA enthalpy, if both OA and RA enthalpy exceed the high limit, Free Cooling turns off.
An alarm is displayed on the LCD	Sensor, damper or the whole working system may not work properly	Check sensor, damper or the whole working system following the detailed alarm information.
RS485 communication failure	RS485 signal or configuration error	Check wiring, configuration, Baud Rate (using mobile app) and other network communication parameters.
Firmware update failure	Application file is damaged Operation is incorrect USB flash disk doesn't work properly	Reload a BIN file, restart the controller, update firmware following Firmware Update [→ 31] or change a USB flash disk. Contact your service provider if failure still exists.
WLAN connection failure	WLAN stick error or wrong user name and password	Plug out and plug in the WLAN stick, enter a correct user name and password, restart the controller or change a WLAN stick. If the WLAN stick is POL903.00/100, the default user name and password are Siemens-WiFi-Stick and SIBPAdmin. See document CC1N7219en for more details.

9 Appendix A: Modbus Addresses

RegNo (Adr+1)	Function Code	Register-Name	Parameter in HMI	BACnet Data Type
1001	04 Read Input Register	OATP	1OAT PRES	AVAL
1002				
1003	04 Read Input Register	RATP	1RAT PRES	AVAL
1004				
1005	04 Read Input Register	OAHP	1OAH PRES	AVAL
1006				
1007	04 Read Input Register	RAHP	1RAH PRES	AVAL
1008				
1009	04 Read Input Register	MATP	1MAT PRES	AVAL
1010				
1011	04 Read Input Register	DP	N/A; Corresponding BACnet object name is DP and analog value is 367.	AVAL
1012				
1013	04 Read Input Register	CO2P	1CO2 PRES	AVAL
1014				
1015	04 Read Input Register	4DAFB	1ACT POS	AVAL
1016				
1017	04 Read Input Register	4DAPP	N/A; Corresponding BACnet object name is 4DAPP and analog value is 316.	AO
1018				
1019	04 Read Input Register	AO_2_1	N/A; Corresponding BACnet object name is AO_2_1 and analog output is 11. Related HMI item: 1VFD SPD	AO
1020				
1021	04 Read Input Register	1DCV	2DCV	AVAL
1022				
1023	04 Read Input Register	2MTS	3MAT SET	AVAL
1024				
1025	04 Read Input Register	2ERV	2ERV SET	AVAL
1026				
1027	04 Read Input Register	2FRZ	3FRZ PROT	AVAL
1028				
1029	04 Read Input Register	2CF	2FAN	AVAL
1030				
1031	04 Read Input Register	1TSO	2TEMP OFF	AVAL

RegNo (Adr+1)	Function Code	Register-Name	Parameter in HMI	BACnet Data Type
1032				
1033	04 Read Input Register	1ESO	2ENTH OFF	AVAL
1034				
1035	04 Read Input Register	ControlMode	N/A; Corresponding BACnet object name is ControlMode and analog value is 329	AVAL
1036				
1201	04 Read Input Register	4OCC	1OCCUPIED	BVAL
1202	04 Read Input Register	4Y1I	1Y1-IN	BVAL
1203	04 Read Input Register	4Y2I	1Y2-IN	BVAL
1204	04 Read Input Register	1AUX1-I	1AUX1-I	BVAL
1205	04 Read Input Register	1AUX2-I	1AUX2-I	BVAL
1206	04 Read Input Register	4Y1O	1Y1-OUT	BVAL
1207	04 Read Input Register	4Y2O	1Y2-OUT	BVAL
1208	04 Read Input Register	1AUX1-O	1AUX1-O	BVAL
1209	04 Read Input Register	1AUX2-O	1AUX2-O	BVAL
1210	04 Read Input Register	4FRE	1FREECOOL	BVAL
1211	04 Read Input Register	4ECO	1ECON ENAB	BVAL
1212	04 Read Input Register	4HEAT	1HEAT ENAB	BVAL
1213	04 Read Input Register	5GeneralAlarm	NO ALARM	BVAL
1501	03 Read Holding Register 16 Write Multiple Registers	1DCV	2DCV	AVAL
1502				
1503	03 Read Holding Register 16 Write Multiple Registers	2MTS	3MAT SET	AVAL
1504				
1505	03 Read Holding Register 16 Write Multiple Registers	2ERV	2ERV SET	AVAL
1506				
1507	03 Read Holding Register 16 Write Multiple Registers	2FRZ	3FRZ PROT	AVAL
1508				
1509	03 Read Holding Register 16 Write Multiple Registers	2CF	2FAN	AVAL
1510				
1511	03 Read Holding Register 16 Write Multiple Registers	1TSO	2TEMP OFF	AVAL
1512				

RegNo (Adr+1)	Function Code	Register-Name	Parameter in HMI	BACnet Data Type
1513	03 Read Holding Register 16 Write Multiple Registers	1ESO	2ENTH OFF	AVAL
1514				

10 Appendix B: QFM2160U Graphs

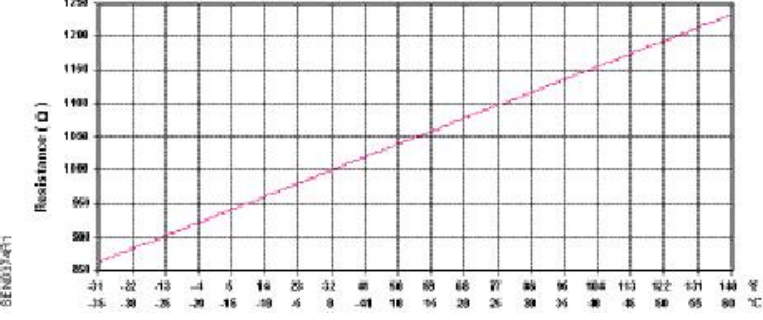
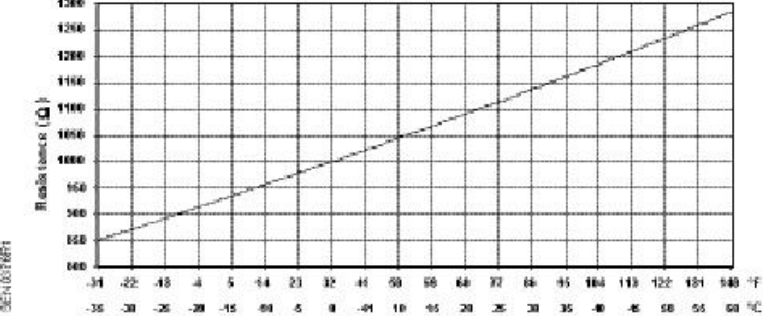
Relative Humidity	<p>The sensor measures the relative humidity in the air duct via its capacitive humidity sensing element whose electrical capacitance changes according to the relative humidity of the ambient air.</p> <p>The electronic measuring circuit converts the sensor's signal to a continuous 0 to 10 Vdc or 4 to 20 mA signal, which corresponds to 0 to 100% relative humidity. In the range 0 to 9.5 V or 4 to 19.2 mA (0 to 95% rh), the signal is linear to the measuring accuracy given in the Specifications section, resulting in an effective measuring range of 0 to 95% rh.</p>
Temperature	<p>The sensor measures the temperature in the air duct via its sensing element whose electrical resistance changes according to the temperature of the ambient air.</p> <p>Depending on the type of sensor, this change in resistance is converted either to an active 0 to 10 Vdc or 4 to 20 mA output signal corresponding to a temperature range of -40°F to 158°F (-40°C to 70°C); -31°F to 95°F (35°C to 35°C); or is provided as a passive output signal ($\hat{=}$ -31°F to 140°F [-35°C to 60°C]).</p>
Sensing Elements, Synthetic Resistance Output	<div style="text-align: center;">  <p>Figure 1. 1000 ohm Platinum.</p> </div> <div style="text-align: center;">  <p>Figure 2. Siemens 1000 ohm Nickel.</p> </div>



See document [155-748](#) for more information about QFM2160U.

11 Appendix C: QFR/QAR9530 Graphs

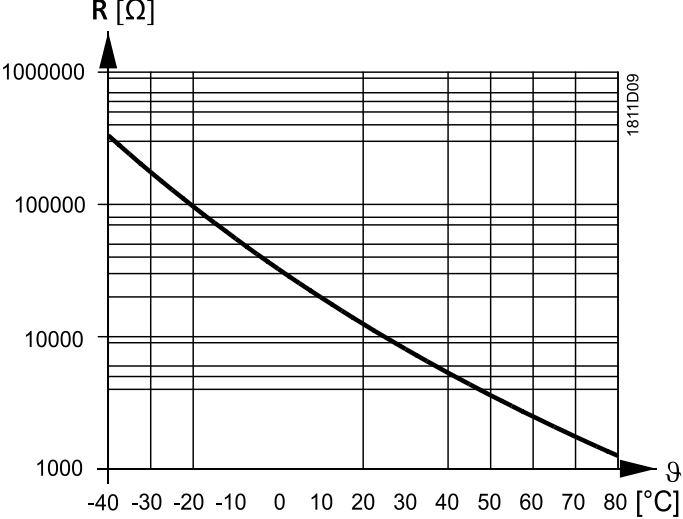
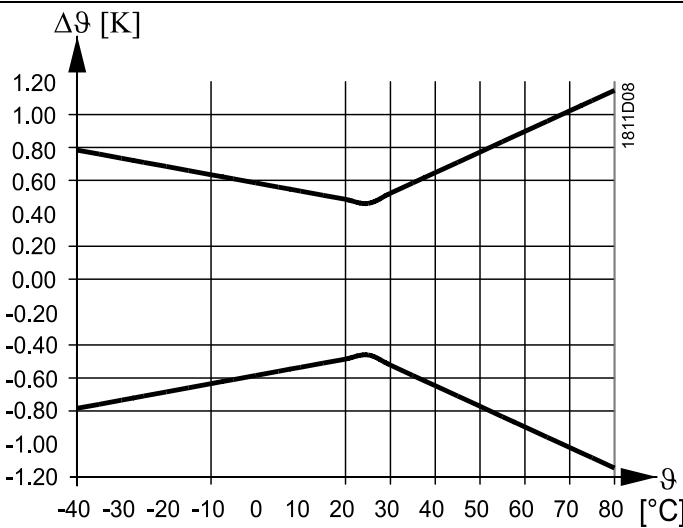
Relative Humidity (QFR9530)	The sensor acquires the relative humidity in the duct via its capacitive humidity sensing element whose electrical capacitance changes as a function of relative humidity. The electronic measuring circuit converts the sensor's signal to a continuous 0...10 Vdc signal, corresponding to a relative humidity range of 0...100 %.
Temperature (QFR9530 & QAR9530)	The sensor acquires the temperature in the duct via its sensing element whose electrical resistance changes as a function of the temperature. The signal is delivered to a suitable controller for further handling.
Sensing Element, NTC 10K	 <p style="text-align: center;">Figure 3. Characteristic.</p>  <p style="text-align: center;">Figure 4. Accuracy.</p>

Legend	R	Resistance value in Ohm
	θ	Temperature in degrees Celsius
	Δθ	Temperature differential in Kelvin



See document [A6V11937911](#) for more information about QFR/QAR9530.

Issued by
Siemens Industry, Inc.
Smart Infrastructure
1000 Deerfield Pkwy
Buffalo Grove IL 60089
+1 847-215-1000